

**OUT-OF-PLANE VIBRATIONS OF PLANAR
CURVED BEAMS HAVING VARIABLE
CURVATURE AND CROSS-SECTION**

**A Thesis Submitted to
the Graduate School of Engineering and Sciences of
İzmir Institute of Technology
in Partial Fulfillment of the Requirements for the Degree of**

MASTER OF SCIENCE

in Mechanical Engineering

**by
Kaan KAYGISIZ**

**June 2012
İZMİR**

We approve the thesis of **Kaan KAYGISIZ**

Examining Committee Members:

Prof. Dr. Bülent YARDIMOĞLU
Department of Mechanical Engineering,
İzmir Institute of Technology

Assoc. Prof. Dr. Moghtada MOBEDI
Department of Mechanical Engineering,
İzmir Institute of Technology

Assist. Prof. Dr. Levent AYDIN
Department of Mechanical Engineering,
İzmir Katip Çelebi University

29 June 2012

Prof. Dr. Bülent YARDIMOĞLU
Supervisor, Department of Mechanical Engineering,
İzmir Institute of Technology

Prof. Dr. Metin TANOĞLU
Head of the Department of
Mechanical Engineering

Prof. Dr. R. Tuğrul SENGER
Dean of the Graduate School
of Engineering and Sciences

ACKNOWLEDGEMENTS

Apart from the efforts of me, the success of any project depends largely on the encouragement and guidelines of many others. I take this opportunity to express my gratitude to the people who have been instrumental in the successful completion of this study.

First and foremost, I would like to thank to my advisor of this thesis, Prof. Dr. Bülent YARDIMOĞLU who was abundantly helpful and offered invaluable assistance, support and guidance. Without his encouragement and guidance this study would not have concluded.

I also wish to express my appreciations to my friends for keeping me up. I admire the patience of my housemate Osman Burak AŞIK. Besides, I am indebted to Yusuf DİLER, Sedat SAVAŞ and İsmail AKÇOK for their supports throughout the hard times of my life.

Finally, yet importantly, I would like to express my heartfelt thanks to my beloved family for their blessings, for their helps and wishes for the successful completion of this thesis. Special thanks go to Ceylin & Ceren, who are the newly quests of KILMEN and ÖZTÜRK families, for reminding us the value of life.

ABSTRACT

OUT-OF-PLANE VIBRATIONS OF PLANAR CURVED BEAMS HAVING VARIABLE CURVATURE AND CROSS-SECTION

In this study, out of plane vibration characteristics of curved beams having variable curvatures and cross-sections are studied by FDM (Finite Difference Method). The effects of curvature and cross-section of the curved beam on natural frequencies are investigated for the curved beams having; variable curvature & constant cross-section and variable curvature & variable cross-section. Mathematical model of the present problem is based on the coupled differential eigenvalue problem with variable coefficients. Numerical solutions of the problem in this study are obtained by the computer program developed in Mathematica. The accuracy of the present results obtained from the developed program is evaluated by comparing with FEM (Finite Element Method) results found from solid model created in ANSYS. Good agreement is obtained in the comparisons of the present results with other results. All results are presented in tabular and graphical forms.

ÖZET

DEĞİŞKEN EĞRİLİK VE KESİTE SAHİP DÜZLEMSEL EĞRİ ÇUBUKLARIN DÜZLEM DIŐI TİTREŐİMLERİ

Bu alıőmada, deėiŐken eėrilik yarıapı ve kesit alanına sahip eėri ubukların dűzlem dıŐı titreŐim karakteristikleri Sonlu Farklar Yöntemi ile incelenmiŐtir. Eėri ubuėun eėriliėinin ve kesitinin doėal frekanslara etkileri; deėiŐken eėrilik-sabit kesit ve deėiŐken eėrilik-deėiŐken kesit durumları iin araŐtırılmıŐtır. Mevcut problemin matematiksel modeli deėiŐken katsayılı baėlaŐık diferansiyel özdeėer problemine dayanmaktadır. Bu alıŐmadaki problemin sayısal özümü Mathematica'da geliŐtirilmiŐ bilgisayar programı ile elde edilmiŐtir. GeliŐtirilen programdan elde edilen özűmlerin doėruluėu ANSYS de oluŐturulan katı modelden bulunan Sonlu Elemanlar Metodu sonuları ile karŐılaŐtırılarak deėerlendirilmiŐtir. Mevcut sonuların diėer sonular ile karŐılaŐtırılmasından iyi uyum elde edilmiŐtir. Tüm sonular tablolar ve grafikler olarak sunulmuŐtur.

TABLE OF CONTENTS

LIST OF FIGURES	vii
LIST OF TABLES	viii
LIST OF SYMBOLS	ix
CHAPTER. 1. GENERAL INTRODUCTION	1
CHAPTER.2. DIFFERENTIAL EQUATIONS AND THEIR SOLUTIONS	7
2.1. Introduction.....	7
2.2. Description of the Problem	7
2.3. Geometry of Curved Beam	8
2.4. Derivation of the Equations of Motion	10
2.4.1. Newtonian Method	11
2.4.2. Hamilton's Method	13
2.5. Natural Frequencies by Finite Difference Method	16
CHAPTER.3. NUMERICAL RESULTS AND DISCUSSION	18
3.1. Introduction.....	18
3.2. Comparisons and Applications for Variable Curvature and Constant Cross-Section	18
3.3. Applications for Variable Curvature and Cross-Section	23
CHAPTER 4. CONCLUSIONS	32
REFERENCES	33

LIST OF FIGURES

<u>Figure</u>	<u>Page</u>
Figure 2.1. Parameters of catenary beam.....	8
Figure 2.2. A planar curved beam with variable curvature and cross section	10
Figure 2.3. A curved beam with internal forces and moments	11
Figure 2.4. A domain divided into six sub domains for approximation	16
Figure 3.1. Convergence of first natural frequency for $R_0=50$ mm and $b_1=h_1=0$	18
Figure 3.2. Comparisons of natural frequencies found for different R_0 by FDM with FEM results.....	20
Figure 3.3. Mode shapes for for $R_0=50$ mm and $b_1=h_1=0$	21
Figure 3.4. Natural frequencies for $b_1=h_1=2/120$	25
Figure 3.5. Natural frequencies for $b_1=h_1=4/120$	26
Figure 3.6. Natural frequencies for $b_1=h_1=6/120$	27
Figure 3.7. Natural frequencies for different $b_1=h_1$	28

LIST OF TABLES

<u>Table</u>	<u>Page</u>
Table 2.1. Finite difference equations	17
Table 3.1. Comparison of natural frequencies found for different R_0 by FDM with FEM results ($b_1=h_1=0$).....	19
Table 3.2. Effects of parameter R_0 on natural frequencies for $b_1=h_1=2/120$	23
Table 3.3. Effects of parameter R_0 on natural frequencies for $b_1=h_1=4/120$	24
Table 3.4. Effects of parameter R_0 on natural frequencies for $b_1=h_1=6/120$	24

LIST OF SYMBOLS

$A(s)$	cross-sectional area of the beam
$b(s)$	breadth function of the beam
b_0	breadth of the beam at root cross-section
b_1	breadth parameter
$B(s)$	angular displacement about z axis as function of s
C_β	the ratio of breadth/depth
E	modulus of elasticity
f	natural frequency
F_y	external force in y direction
G	shear modulus
$h(s)$	depth function of the beam
h_0	depth of the beam at root cross-section
h_1	depth parameter
i	mass polar moment of inertia per unit length
I_{xx}	area moment of inertia of the cross-section about xx axis
$J(s)$	torsional constant of cross-section
m	mass per unit length of the beam
M_x, M_z	bending and twisting moments
N_z	internal force along z axis
R_0	radius parameter of the catenary curve
s	arc length of the curve
s_L	length of the curve
T	kinetic energy
T_z	external twisting moment about z axis
x	co-ordinate axis
$v(s,t)$	displacement in y direction
V	elastic strain energy
$V(s)$	displacement in y direction as function of s
V_y	shear force in y direction
α, α_r	slope of the curve at any point and point r
$\beta(s,t)$	angular displacement about z axis

δ	variation operator
κ	curvature in xz plane
λ	eigenvalue
ρ_0	radius of curvature in xz plane
τ	twist about z axis
$(\dot{})$	differentiation with respect to s
$(\dot{})$	differentiation with respect to time

CHAPTER 1

GENERAL INTRODUCTION

Vibration is the motion of a particle, system of particles or continuous elastic body displaced from a position of equilibrium. In other words, vibration is the study for dynamics of elastic bodies. Vibrations are generally undesired motions for most of the machines and structures. They cause higher stresses, energy losses, increased bearing loads, induced fatigue, wear of machine parts, damage to machines and buildings and discomfort to human beings. On the other hand, vibrations have a vital importance for humans if you think about;

- Beating of heart,
- Breathing - Oscillation of lungs,
- Walking - Oscillation of legs and hands,
- Shivering - Oscillation of body in extreme cold,
- Hearing - Ear receives vibrations to transmit message to brain,
- Speaking - Vocal chords vibrate to make sound.

Curved beam structures have been used in many engineering applications since the nineteenth century. The utilization of these structures can be mostly found out in the mechanical, civil, aerospace engineering and various fields. These applications can be listed for mechanical engineering as follows: spring design, brake shoes within drum brakes, tire dynamics, circumferential stiffeners for shells, turbo machinery blades, in the piping systems of chemical plants, thermal power plants. Also other engineering applications can be found such as: curved girder bridges, design of arch bridges, highway construction, long span roof structures, curved wires in missile-guidance floated gyroscopes, wings of an airplane, propellers of an helicopter; and earthquake resistant structures. It is really necessary to have a sound knowledge of vibrations for a design engineer.

Curved beams can be classified depending on their geometrical properties as;

- in the shape of a space curve or a plane curve,
- constant or variable curvature,
- constant or variable cross section.

In general, the out-of-plane and the in-plane vibrations of curved beams are coupled. However, if the cross-section of the curved beam is uniform and doubly symmetric, then the out-of-plane and the in-plane vibrations are independent (Ojalvo 1962).

Many investigators have been studied out-of-plane vibrations of the curved beams because of the wide usage of curved beams and until now, insignificant researches have been performed for variable curvatures and cross-sections. Some of those researches are introduced in the next paragraphs with the inclusion of their various methods.

Volterra and Morell (1961) used the Rayleigh-Ritz method to determine the lowest natural frequencies of elastic arcs with clamped ends. They managed to formulate the relationships for the length and the radius of curvature of a circle, a cycloid, a catenary and a parabola.

Chang and Volterra (1969) developed an extended method based on the differential operator theory to determine the upper and the lower bounds of the first four natural frequencies of simply-supported arcs with central lines in the forms of circles, cycloids, catenaries and parabolas. The numerical values of the frequencies are compared with the results obtained by the Rayleigh-Ritz.

Wang (1975) studied the analysis of the lowest natural frequency of the out-of-plane vibration for a clamped elliptic arc of constant section. The Rayleigh-Ritz method is employed to obtain the frequency equation and the numerical results are presented in the form of curves. The effects of the opening angle on the natural frequencies of the arc are shown in these curves.

Takahashi and Suzuki (1977) studied the vibrations of an uniform bar, of which the center line is an arc of ellipse and which vibrates perpendicularly to the plane of center line, neglecting the rotary inertia and the deformation due to shear. From the Lagrangian of the bar, equation of motion and the boundary conditions are obtained. By integrating the curvature along center line a new independent variable introduced to simplify these equations and boundary conditions. The solution was found out as a form of power series.

Suzuki et al. (1978) used the Rayleigh-Ritz and Lehmann-Maehly methods to determine frequencies and mode shapes of various curved bars with clamped ends. At the same time, they carried out numerical calculations about symmetric ellipse, sine

catenary, hyperbola, parabola and cycloid arcs. They obtained a common tendency for the vibrations of curved bars.

Irie et al. (1980) presented an analysis of the steady state out-of-plane vibration of a free-clamped Timoshenko beam with internal damping by using the transfer matrix approach. The equations of the beam are written in a matrix differential equation of first order by use of this method. The method is applied to free-clamped non-uniform beams with circular, elliptical, catenary and parabolical neutral axes. The elements of the matrix are determined by numerical integration, thus from the matrix and the boundary conditions, all the other variables are determined.

Suzuki and Takahashi (1981) presented a method for a free out-of-plane vibrations of a plane curved bar including the effects of the bending, the torsion, the shear deformation and the rotatory inertia of bar. Timoshenko's beam theory is used to derive the basic equations. First, the Lagrangian of vibration of a curved bar is obtained and the equations of vibration and the boundary conditions are determined. Then, the equations are solved exactly by series solution. Natural frequencies and mode shapes for symmetric catenary, parabola and cycloid curved bars with clamped ends are obtained. The numerical results with this theory are compared with the ones by the classical theory. A good agreement is reached and the effects of the shear deformation and the rotator inertia are clarified.

Suzuki et al. (1983) used classical theory for the out-of-plane free vibrations of a plane curved bar with an arbitrary varying cross-section. The equations and the boundary conditions are determined from the Lagrangian of the bar. Equations are solved exactly in series solution. The natural frequencies and the mode shapes of an elliptic arc bars with both clamped ends and both simply supported ends are obtained.

Kawakami et al. (1995) presented a method for the free vibration analysis for both the in-plane and the out-of-plane cases of horizontally curved beams with arbitrary shapes and variable cross-sections. Firstly, the fundamental equations of a curved beam are transformed into integral equations and the discrete Green functions are obtained by approximate solution of these equations. Secondly, according to the integral theorem, the fundamental equations transformed into equivalent boundary integral equations. Finally, the eigenvalues for free vibration are obtained by applying the Green function and using the numerical integration. Numerical results are compared with those obtained by a FEM and the effectiveness of the proposed method is confirmed.

Huang and Chang (1998) presented an extended methodology for analyzing the out-of-plane dynamic responses of arches which was used to solve in-plane ones before. An exact solution is formulated for the transformed governing equations in the Laplace transform domain. Key elements for the solution such as dynamic stiffness matrix and equivalent nodal loading vector for a curved bar are also formulated. The analytical solution in the Laplace domain is obtained by using the Frobenius method. The results for the displacement component and the stress resultants are given to show the accuracy of this method. The most important advantage of this method is providing accurate dynamic responses both for the displacement components and for the higher derivatives of displacement without any difficulties.

Huang et al. (2000) investigated the linear out-of-plane dynamic responses of planar curved beams with arbitrary shapes and cross-sections including the effects of shear deformation and rotary inertia. Frobenius method is used to develop a series solution for curved beams in terms of polynomials. The exact solution for the out-of-plane free vibration of a curved beam is established by transforming the solution in the Laplace domain into the frequency domain. This solution is not limited with symmetry; both symmetric and anti-symmetric modes are formulated together. Accurate results can be obtained with the help of Laplace transform and an analytical solution in the Laplace domain is concluded in higher accuracy for stress resultants. A convergence study is also presented to demonstrate the validity of proposed solution.

Lee and Chao (2000) derived the governing equations for the out-of-plane vibrations of a curved non-uniform beam of constant radius via Hamilton's principle. A non-uniform beam with double symmetric cross-section situation is considered. The thickness of the beam assumed as so small in comparison with the radius of the beam. Thus, the shear deformation, the rotary inertia and the warping effects are not taken into account. By introducing two physical parameters, the analysis is simplified and it is found that the torsional displacement and its derivative can be explicitly expressed in terms of the flexural displacement. The two coupled governing characteristic differential equation are decoupled and reduced to one sixth-order ordinary differential with variable coefficients in the out-of-plane flexural displacement. Exact solutions for the out-of-plane vibrations of non-uniform curved beams are obtained. The study for a curved non-uniform beam is successfully revealed with the help of explicit relations. The influence of taper ratio, center angle and arc length on the first two natural frequencies of the beam is also studied.

Kim et al. (2003) presented an improved energy formulation for spatially coupled free vibration and buckling of non-symmetric thin-walled curved beams with variable curvatures. By introducing the displacement field and considering the effects of variable curvatures, the total potential energy of non-circular curved beam is derived and then a beam element for Finite Element Analysis is developed. Numerical solutions are illustrated to show the accuracy and the validity of this element. The influences of the arch rise to span length ratio on spatial vibrations and buckling behaviors of non-circular beams with the parabolic and elliptic shapes are also investigated.

Tüfekçi and Doğruer (2006) aimed to give the exact solution to the governing equations of the out-of-plane deformation of an arch of general geometry and also exhibit the advantages of the solution by using the initial value method considering the shear deformation effect. The stress resultants and displacements throughout the beam are found with the help of initial values of these parameters. The main advantage of this method is that the higher degree of statically indeterminacy does not add any difficulty to the solution. The examples in the literature are also solved and the results are compared with each others.

Lee et al. (2008) derived the governing differential equations out-of-plane free vibrations of the elastic, horizontally curved beams with variable curvatures and solved numerically to obtain natural frequencies and mode shapes for parabolic, sinusoidal and elliptic beams with hinged-hinged, hinged-clamped and clamped-clamped end constraints. The effects of the shear deformation, rotatory and torsional inertias are considered whereas the warping of the cross-section is excluded. Non-dimensional equations of the stress resultants are formulated to present the mode shapes and deformations. Experimental methods are also described for measuring the free vibration frequencies for parabolic beams, which agree well with those predicted by theory.

In spite of the fact that, there is no considerable amount of the researches, so the vibration characteristic is seemed to be an interesting and a worth studying subject since the variety and the complexity of the effects of the parameters are taken into account. Therefore, in this study, the effects of variable radius of curvature and cross-section on vibration characteristics of curved beams are studied. Finite Difference Method is used to reduce to differential eigenvalue problem to discrete eigenvalue problem to solve numerically. A symbolic computer program is developed in Mathematica to determine the eigenvalues. Using the developed program, natural frequencies are obtained and the effects of parameters such as variable radius of curvature and cross-section are found.

The accuracy and numerical precision of the developed program are evaluated by using the finite element model results found from the solid model created and solved in ANSYS. A very good agreement is reached in the comparisons of the present results with FEM results. The effects of cross-section and curvature variation parameters are given in tabular and graphical form.

CHAPTER 2

DIFFERENTIAL EQUATIONS AND THEIR SOLUTIONS

2.1. Introduction

In this chapter, all the necessary information to identify the problem is given. The geometry of the beam is given and the radius of the curvature is expressed in desired form. Newtonian method and Hamilton's principle are presented which are used to derive the equation of motions. Boundary conditions are listed for different types of end conditions: clamped, pinned and free.

The governing differential equations of motions for free vibrations which are derived from the Hamilton's principle based on the energy equations are introduced. By using the separation of variable method, the problem is transformed into one dimensional eigenvalue problem with variable coefficients.

A numerical approach is needed to solve this eigenvalue since the differential equations having variable coefficients are analytically unsolvable in most cases. The differential eigenvalue problem is reduced to discrete eigenvalue problem by using Finite Difference Method. Finally, discrete eigenvalue problem regarding the natural frequencies and the mode shapes is introduced as generalized eigenvalue problem.

2.2. Description of the Problem

The out-of-plane free vibrations of a uniform curved beam of which the center line is a plane curve having variable curvature and cross-section are considered. The material of the beam is assumed as isotropic. The problem is chosen as a cantilever beam; one end is fixed and other end is free. The boundary conditions are written for this end conditions. The cases of variable radius of curvature and constant cross-section and variable radius of curvature and variable cross-section are investigated in order to find out the effects of the parameters on vibration characteristics.

2.3. Geometry of Curved Beam

In this study, a curved beam in the shape of a catenary curve is selected. Geometrical properties of the selected curve are presented with the aid of Figure 2.1.

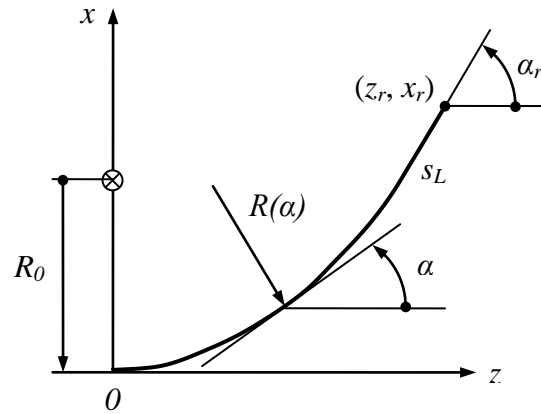

Figure 2.1. Parameters of catenary beam

The function of the catenary curve in cartesian coordinate system is written as follows (Yardimoglu, 2010):

$$x(z) = R_0[\cosh(z/R_0) - 1] \quad (2.1)$$

The slope α of the curve at any point is obtained by differentiation of Equation 2.1 with respect to z as

$$\tan \alpha = dx(z)/dz = \sinh(z/R_0) \quad (2.2)$$

The tip co-ordinates of the curved beam (z_r, x_r) can be expressed in terms of α_r as

$$z_r = R_0 \operatorname{arc} \sinh(\tan \alpha_r) \quad (2.3)$$

$$x_r = R_0 (1/\cos \alpha_r - 1) \quad (2.4)$$

Since the arc length s from origin to any point (z, x) on the curve is determined by using the well-know equation (Riley et al. 2006)

$$s = \int_0^s \sqrt{1 + (dx(z)/dz)^2} dz \quad (2.5)$$

the following relationship between s and α is obtained:

$$s = R_0 \tan \alpha \quad (2.6)$$

Similarly, the arc length s_L from origin to point (z_r, x_r) can be expressed as

$$s_L = R_0 \tan \alpha_r \quad (2.7)$$

Radius of curvature at z is found as

$$\rho_0(z) = \frac{[1 + (dx(z)/dz)^2]^{3/2}}{d^2x(z)/dz^2} = R_0 \cosh^2(z/R_0) \quad (2.8)$$

Eliminating the variable z in Equation 2.8 by using Equation 2.2, radius of curvature can be written in terms of α as follows:

$$\rho_0(\alpha) = R_0 / \cos^2 \alpha \quad (2.9)$$

Now, $\cos \alpha$ can be expressed in terms of s by using Equation 2.6 as

$$\cos \alpha = R_0 / \sqrt{R_0^2 + s^2} \quad (2.10)$$

Therefore, radius of curvature can also be written in terms of s as follows:

$$\rho_0(s) = R_0 + s^2 / R_0 \quad (2.11)$$

A planar curved beam with variable curvature and cross section is shown Figure 2.2. The breadth and depth functions of the curved beam are selected as follows

$$b(s) = b_0 - b_1 s \quad (2.12)$$

$$h(s) = h_0 - h_1 s \quad (2.13)$$

where b_0 and h_0 are breadth and depth of curved beam at $s=0$, respectively. Also, b_1 and h_1 are breadth and depth parameters.

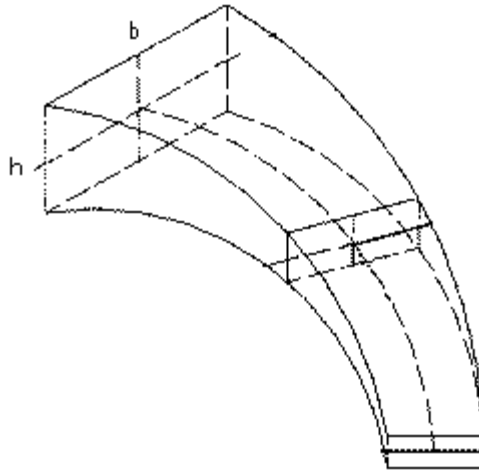

Figure 2.2. A planar curved beam with variable curvature and cross section

2.4. Derivation of the Equation of Motion

In this section, derivations of equations of motion for out of plane motion of curved beam having variable radius of curvature and variable cross-section are presented by two methods which are Newtonian Method and Hamilton's Principle. The advantages of Hamilton's principle are stated. Then, physical interpretations for boundary conditions are listed.

2.4.1. Newtonian Method

Newtonian method is a vectorial approach in order to obtain the equilibrium equations. The main drawback of the Newtonian method is that it requires free-body diagram of the system including all forces and moments acting on the system. Also, linear and angular accelerations of the system are necessary.

Newtonian method is based on the following two vectorial equations:

$$\sum_i \vec{F}_i = m\vec{a} \quad (2.14)$$

$$\sum_i \vec{M}_i = I\vec{\alpha} \quad (2.15)$$

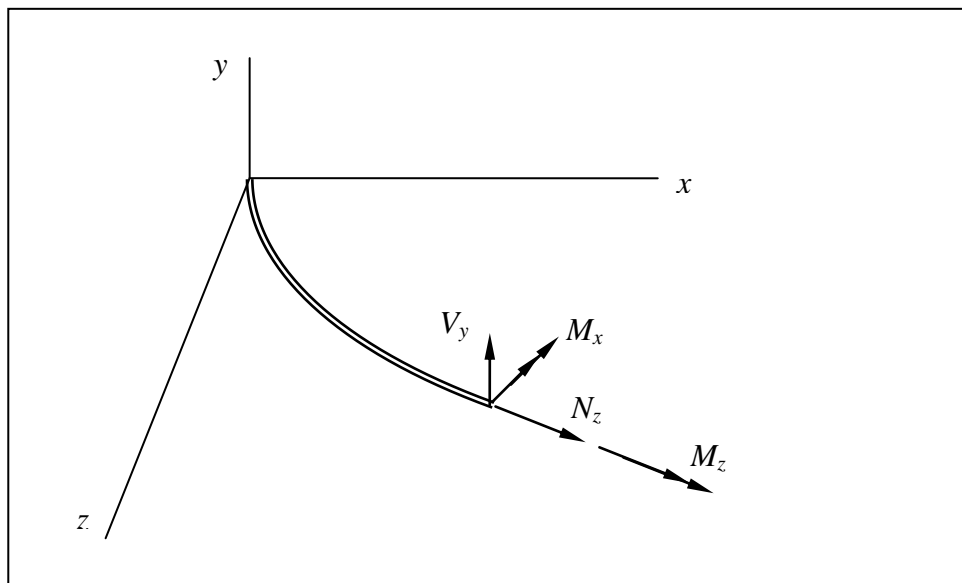

Figure 2.3. A curved beam with internal forces and moments

Internal forces due to the out of plane motion of a planer curved beam are shown in Figure 2.3. By using Equations 2.14 and 2.15, force and moment equilibrium equations of the present curved beam can be obtained as follows (Love 1944):

$$\frac{dV_y}{ds} + F_y = m\ddot{v} \quad (2.16)$$

$$\frac{dM_x}{ds} + \frac{M_z}{\rho_0} - V_y = 0 \quad (2.17)$$

$$\frac{dM_z}{ds} - \frac{M_x}{\rho_0} + T_z = i \ddot{\beta} \quad (2.18)$$

where the overdot shows the differentiation with respect to time, m and i are mass per unit length and mass polar moment inertia per unit length, respectively. They can be written in terms of density ρ and cross-sectional properties A and J as follows:

$$m = \rho A \quad (2.19)$$

$$i = \rho J \quad (2.20)$$

where $A(s)$ and $J(s)$ are cross-sectional area and torsional constant of cross-section. Bending and twisting moments in Equation 2.17 and 2.18 are given as

$$M_x = EI_{xx} \kappa \quad (2.21)$$

$$M_z = GJ \tau \quad (2.22)$$

in which

$$\kappa = \left(\frac{\beta}{\rho_0} - \frac{\partial^2 v}{\partial s^2} \right) \quad (2.23)$$

$$\tau = \left(\frac{d\beta}{ds} + \frac{1}{\rho_0} \frac{\partial v}{\partial s} \right) \quad (2.24)$$

It should be noted that external force in y direction F_y and external twisting moment about z axis T_z are zero for free vibration analysis.

The disadvantage of this method is expressing the boundary conditions which are based on the understanding of the internal forces and moments.

2.4.2. Hamilton's Method

The Hamilton's principle is the most powerful variational principle of mechanics. It permits the formulation of problems of dynamics in terms of two scalar functions, the kinetic energy and the potential energy, Moreover, it gives associated boundary conditions where Newtonian method encounters difficulties, especially in distributed-parameter systems.

The principle can be stated as follows; “Of all possible time histories of displacement states that satisfy the compatibility equations and the constraints or the kinematic boundary conditions and that also satisfy the conditions at initial and final times t_1 and t_2 , the history to the actual solution makes the Langrangian a minimum” (Meirovitch 1967). The principle can be defined mathematically as follows:

$$\delta \int_{t_1}^{t_2} (T - V) dt = 0 \quad (2.25)$$

Where T is the kinetic energy and V is the elastic strain energy due to the out of plane motions of the curved beam. Kinetic energy and elastic strain energy of the curved beam are given as follows;

$$T = \frac{1}{2} \int_0^{S_L} (m \dot{v}^2 + i \dot{\beta}^2) ds \quad (2.26)$$

$$V = \frac{1}{2} \int_0^{S_L} (M_x \kappa + M_z \tau) ds \quad (2.27)$$

If Equations 2.19 and 2.20 are substituted into Equation 2.26, and Equations 2.21 and 2.22 are substituted into Equation 2.27, the following equations are written:

$$T = \frac{1}{2} \int_0^{S_L} (\rho A \dot{v}^2 + \rho J \dot{\beta}^2) ds \quad (2.28)$$

$$V = \frac{1}{2} \int_0^{S_L} (EI_{xx} \kappa^2 + GJ \tau^2) ds \quad (2.29)$$

Using the kinetic and elastic energies given in Equations 2.28 and 2.29 along with Equations 2.23 and 2.24 in Equation 2.25, governing differential equations for vibrations of curved beams having variable radius of curvature and cross-section and associated boundary conditions can be obtained as follows:

$$\frac{\partial^2}{\partial s^2} \left[E I_x \left(\frac{\beta}{\rho_0} - \frac{\partial^2 v}{\partial s^2} \right) \right] + \frac{\partial}{\partial s} \left[\frac{G J}{\rho_0} \left(\frac{\partial \beta}{\partial s} + \frac{1}{\rho_0} \frac{\partial v}{\partial s} \right) \right] = \rho A \ddot{v} \quad (2.30)$$

$$\frac{E I_x}{\rho_0} \left(\frac{\partial^2 v}{\partial s^2} - \frac{\beta}{\rho_0} \right) + \frac{\partial}{\partial s} \left[G J \left(\frac{\partial \beta}{\partial s} + \frac{1}{\rho_0} \frac{\partial v}{\partial s} \right) \right] = \rho J \ddot{\beta} \quad (2.31)$$

The associated boundary conditions are:

$$\frac{E I_x}{\rho_0} \left(\frac{\partial^2 v}{\partial s^2} - \frac{\beta}{\rho_0} \right) \delta v' \Big|_0^{s_L} = 0 \quad (2.32)$$

$$G J \left(\frac{\partial \beta}{\partial s} + \frac{1}{\rho_0} \frac{\partial v}{\partial s} \right) \delta \beta \Big|_0^{s_L} = 0 \quad (2.33)$$

$$\left\{ \frac{\partial}{\partial s} \left[E I_x \left(\frac{\beta}{\rho_0} - \frac{\partial^2 v}{\partial s^2} \right) \right] + \frac{G J}{\rho_0} \left(\frac{\partial \beta}{\partial s} + \frac{1}{\rho_0} \frac{\partial v}{\partial s} \right) \right\} \delta v \Big|_0^{s_L} = 0 \quad (2.34)$$

In Equation 2.32, prime represents the differentiation with respect to s .

Physical interpretations for boundary conditions corresponding to Equations 2.32-2.34 are as follows, respectively:

- a) Either bending moment is zero (pinned or free), or slope is zero (clamped).
- b) Either twisting moment is zero (pinned or free), or rotation is zero (clamped).
- c) Either shear force is zero (free), or displacement is zero (pinned or clamped)

If the boundary conditions of the curved beam are homogeneous as in Equations 2.32-2.34, the solutions of Equations 2.30-2.31 are assumed as

$$v(s,t) = V(s)T(t) \quad (2.35)$$

$$\beta(s,t) = B(s)T(t) \quad (2.36)$$

where $V(s)$ and $B(s)$ are linear and angular displacements as function of s , respectively. Time dependent function can be chosen as $T(t) = \exp(i\omega t)$ in which ω is the circular natural frequency of the harmonic vibrations. Thus, Equations 2.30-2.31 are reduced to following coupled differential eigenvalue problem in terms of $V(s)$ and $B(s)$:

$$\frac{d^2}{ds^2} \left[EI_x(s) \left(\frac{B(s)}{\rho_0(s)} - \frac{d^2V(s)}{ds^2} \right) \right] + \frac{d}{ds} \left[\frac{GJ(s)}{\rho_0(s)} \left(\frac{dB(s)}{ds} + \frac{1}{\rho_0(s)} \frac{dV(s)}{ds} \right) \right] = -\omega^2 \rho A(s) V(s) \quad (2.37)$$

$$\frac{EI_x(s)}{\rho_0(s)} \left(\frac{d^2V(s)}{ds^2} - \frac{B(s)}{\rho_0(s)} \right) + \frac{d}{ds} \left[GJ(s) \left(\frac{dB(s)}{ds} + \frac{1}{\rho_0(s)} \frac{dV(s)}{ds} \right) \right] = -\omega^2 \rho J(s) B(s) \quad (2.38)$$

The new boundary conditions as functions of s can be obtained easily by replacing d instead of ∂ in Equations 2.32-2.34 since there is no time dependent term in BCs.

Geometrical properties as function of s are detailed in this paragraph. Area moment of inertia of the cross-section about xx -axis is determined by

$$I_{xx}(s) = \frac{b(s)h(s)^3}{12} \quad (2.39)$$

Equation 2.11 is given here again for completeness,

$$\rho_0(s) = R_0 + s^2 / R_0 \quad (2.40)$$

Torsional constant J for rectangular cross-section is given as (Popov 1998)

$$J(s) = C_\beta b(s)h(s)^3 \quad (2.41)$$

where the values of parameter C_β depends on the ratio of b/h . By using the Equations 2.39-2.41 in Equations 2.37-2.38, the present problem equations are obtained to solve by Finite Difference Method which will be explained in next section.

2.5. Natural Frequencies by Finite Difference Method

The Finite Difference Method is a numerical method for solution of differential equations by using approximate derivatives (Hildebrand 1987).

Since the differential equations having variable coefficients are analytically unsolvable except for equations having special combinations of coefficients, the Finite Difference Method can be used.

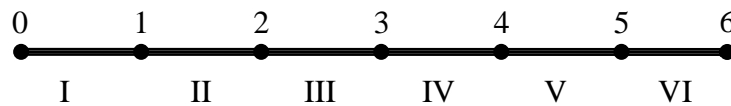

Figure 2.4. A domain divided into six subdomains for approximation

In the Finite Difference Method, the derivatives of dependent variables in the differential equations are replaced by the finite difference approximations at mesh points and these equations are enforced at each mesh points. Therefore, n simultaneous algebraic equations are obtained. In this study, central difference approximation which is detailed in Table 2.1 is used.

Therefore, differential eigenvalue problem given by Equation 2.37-2.38 and associated boundary conditions is reduced to discrete eigenvalue problem which can be written as follows:

$$[A] \{X\} = \lambda [B] \{X\} \quad (2.42)$$

Solutions of the generalized eigenvalue problem given by Equation 2.42 can be obtained by a mathematical software such as Matlab, Mathematica or Maple.

Table 2.1. Finite difference equations

Term	Central Difference Expressions for required derivatives of $V(s)$ and $B(s)$
$\frac{dV}{ds}$	$\frac{V(i+1) - V(i-1)}{2h}$
$\frac{d^2V}{ds^2}$	$\frac{V(i+1) - 2V(i) + V(i-1)}{h^2}$
$\frac{d^3V}{ds^3}$	$\frac{V(i+2) - 2V(i+1) + 2V(i-1) - V(i-2)}{2h^3}$
$\frac{d^4V}{ds^4}$	$\frac{V(i+2) - 4V(i+1) + 6V(i) - 4V(i-1) + V(i-2)}{h^4}$
$\frac{dB}{ds}$	$\frac{B(i+1) - B(i-1)}{2h}$
$\frac{d^2B}{ds^2}$	$\frac{B(i+1) - 2B(i) + B(i-1)}{h^2}$

CHAPTER 3

NUMERICAL RESULTS AND DISCUSSION

3.1. Introduction

In this chapter, numerical applications are carried out for curved beams with different curvature and cross-sectional properties. The main numerical data are as follows: $b_0=h_0=0.01$ m, $E=200$ GPa, $G=80$ GPa, $\rho=7850$ kg/m³, $s_L=0.12$ m. Other data are given in table and figure legends. The numerical results are found and compared with FEM results obtained from solid model created in ANSYS. The results given in tabular and graphical forms are discussed.

3.2. Comparisons and Applications for Variable Curvature and Constant Cross-Section

In this section, as first step, in order to determine the proper number of node in finite difference mesh, the first natural frequencies are found for different number of node and shown in Figure 3.1.

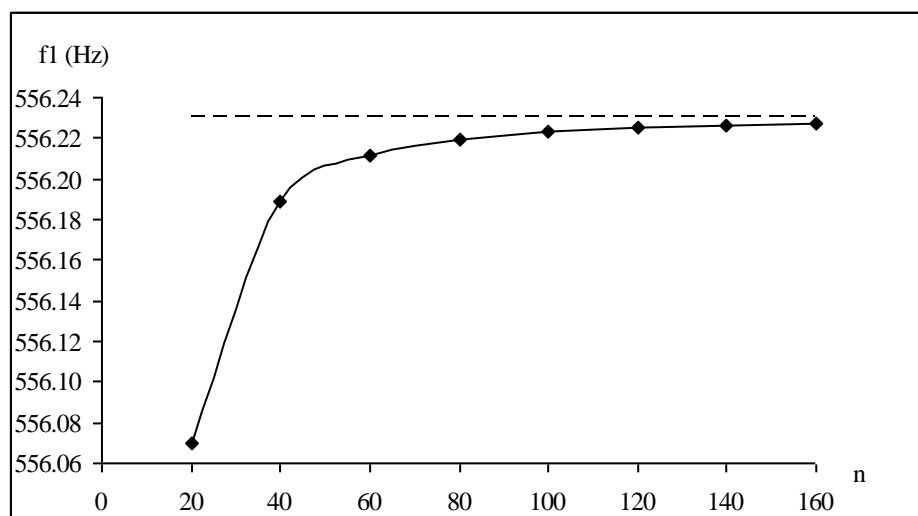

Figure 3.1. Convergence of first natural frequency for $R_0=50$ mm and $b_1=h_1=0$.

Considering the tendency of the curve shown in Figure 3.1, the proper number of node for FDM is selected as 100 for all calculations.

To evaluate the results of FDM for the case of variable curvature and constant cross-section, four different solid models depending on R_0 are created in ANSYS by using 4x4x50 Solid 95 elements.

The natural frequencies found for different R_0 by Finite Difference Models and Finite Element Models are tabulated in Table 3.1 and plotted in Figure 3.2. The mode shapes are given in Figure 3.3.

Table 3.1. Comparison of natural frequencies found for different R_0 by FDM with FEM results ($b_1=h_1=0$)

		$R_0=50$ mm	$R_0=100$ mm	$R_0=150$ mm	$R_0=200$ mm
f_1 (Hz) <i>bending 1</i>	FDM	556.2	562.9	564.7	565.4
	FEM	569.7	568.4	566.6	565.6
f_2 (Hz) <i>bending 2</i>	FDM	3084.5	3157.9	3275.8	3358.3
	FEM	3035.6	3115.0	3221.0	3291.0
f_3 (Hz) <i>torsion 1</i>	FDM	7802.6	7481.7	7186.7	7009.3
	FEM	7812.2	7489.7	7244.8	7106.6
f_4 (Hz) <i>bending 3</i>	FDM	9556.1	9810.8	9891.1	9913.9
	FEM	8968.7	9215.7	9274.6	9283.7
f_5 (Hz) <i>bending 4</i>	FDM	18942.1	19160.5	19227.6	19274.6
	FEM	16909.0	17081.9	17155.1	17194.7
f_6 (Hz) <i>torsion 2</i>	FDM	21118.5	20546.6	20329.9	20217.0
	FEM	21482.7	20993.2	20787.6	20689.9
f_7 (Hz) <i>bending 5</i>	FDM	31422.2	31798.7	31920.0	31982.1
	FEM	26565.2	26778.3	26862.5	26902.5
f_8 (Hz) <i>torsion 3</i>	FDM	34216.9	33656.5	33486.2	33403.8
	FEM	34929.3	34525.7	34379.8	34313.2

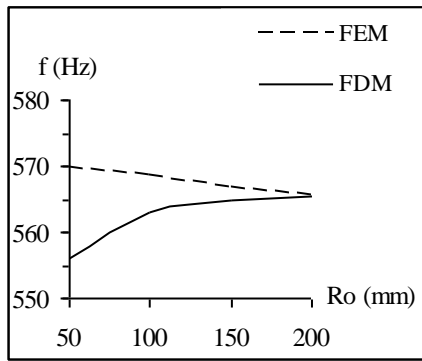

a) Bending 1

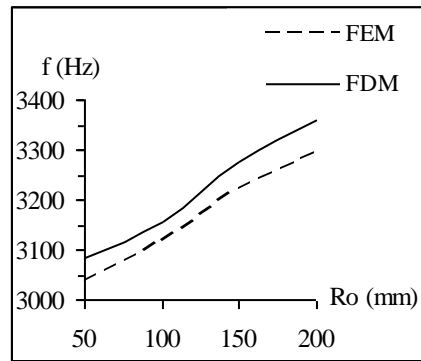

b) Bending 2

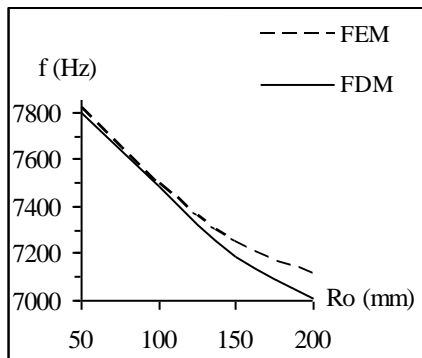

c) Torsion 1

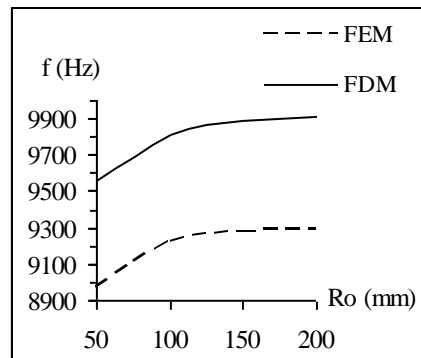

d) Bending 3

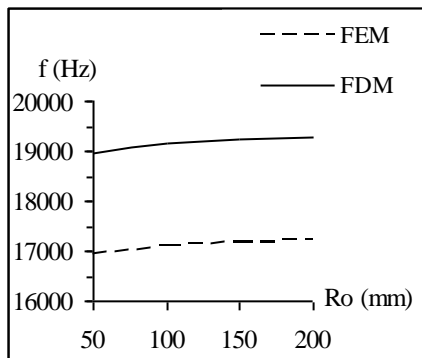

e) Bending 4

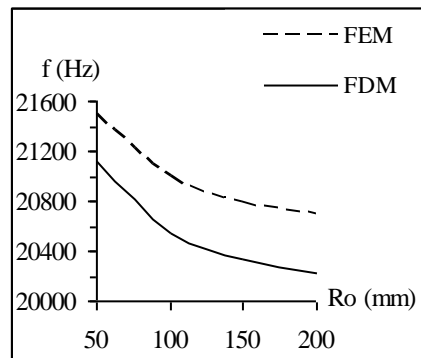

f) Torsion 2

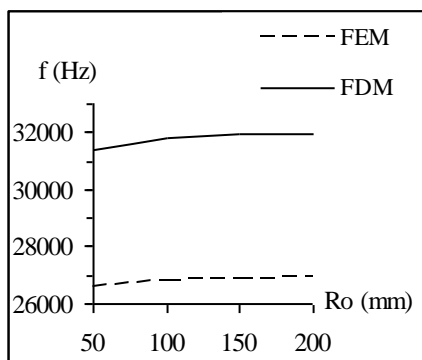

g) Bending 5

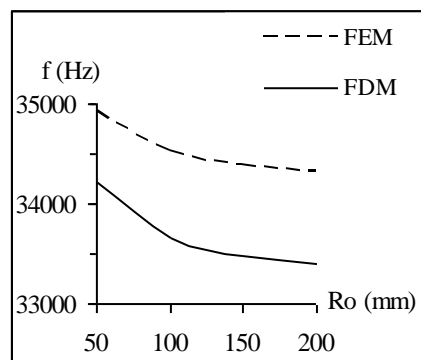

h) Torsion 3

Figure 3.2. Comparisons of natural frequencies found for different R_0 by FDM with FEM results.

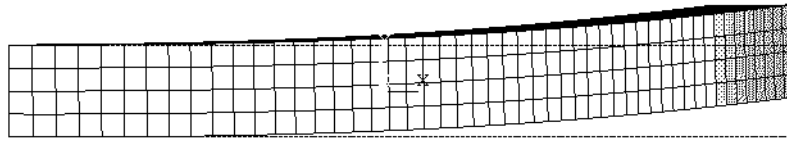

a) First bending mode



b) Second bending mode

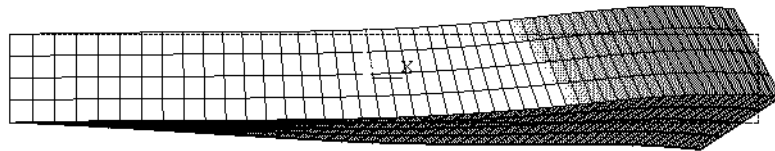

c) First torsion mode

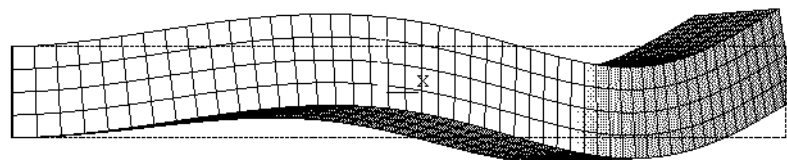

d) Third bending mode

Figure 3.3. Mode shapes for for $R_0=50$ mm and $b_1=h_1=0$ (cont. on next page)

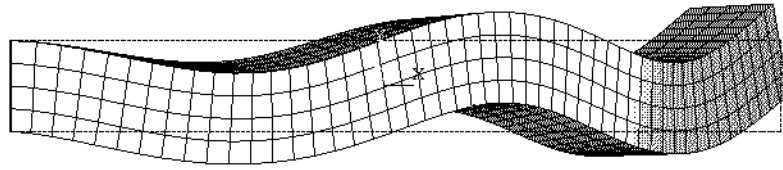

e) Fourth bending mode

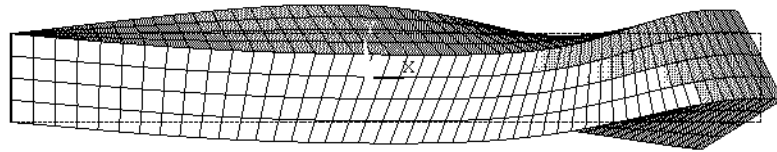

f) Second torsion mode

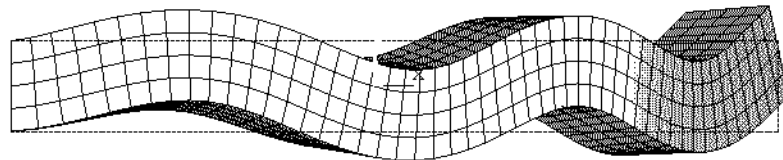

g) Fifth bending mode

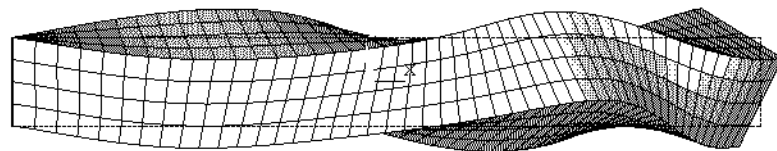

h) Third torsion mode

Figure 3.3. (cont.)

Natural frequencies are plotted in Figures 3.2.a-h separately in the order of mode shapes to see the difference of FDM and FEM results clearly.

In order to show the effect of the R_0 on the natural frequencies of the beam, Figures 3.2.a-h are illustrated as natural frequencies versus R_0 . It can be seen from the Figures 3.2.a-h that the results of FDM and FEM have the same tendency except first bending mode. For the first bending mode, the parameter R_0 is very effective on the results of FDM and FEM. It is very interesting that the FDM and FEM results are almost the same for $R_0=200$ mm. For other cases, it is obvious that when the mode number increases, the differences become more significant.

The beam is in x - z plane as shown in Figures 2.1 or 2.3. The mode shapes given in Figure 3.3.a-h are obtained from FEM. In these figures, bending displacements are in y direction and torsional displacements are about local z axis.

3.3. Applications for Variable Curvature and Cross-Section

Numerical applications for the case of variable curvature and variable cross-section are presented for various radius of curvatures in this section.

Effects of parameter R_0 on natural frequencies for different tapering ratios are studied and the results are given in Table 3.2-4.

Table 3.2. Effects of parameter R_0 on natural frequencies for $b_1=h_1=2/120$

	$R_0=50$ mm	$R_0=100$ mm	$R_0=150$ mm	$R_0=200$ mm
f_1 (Hz)	610.87	617.486	619.338	619.993
f_2 (Hz)	3059.72	3113.66	3201.41	3260.86
f_3 (Hz)	8749.87	8428.42	8229.44	8117.2
f_4 (Hz)	8985.88	9218.79	9215.24	9188.5
f_5 (Hz)	17232.7	17436.8	17517.9	17561.1
f_6 (Hz)	21528.1	20964.9	20733.5	20623.2
f_7 (Hz)	28486.4	28772.1	28878.8	28929.5
f_8 (Hz)	34413.5	33915.4	33745.5	33667.3

Table 3.3. Effects of parameter R_0 on natural frequencies for $b_1=h_1=4/120$

	$R_0=50$ mm	$R_0=100$ mm	$R_0=150$ mm	$R_0=200$ mm
f_1 (Hz)	685.64	692.20	694.00	694.63
f_2 (Hz)	3005.03	3041.14	3102.00	3142.39
f_3 (Hz)	7979.17	8060.64	8111.62	8148.87
f_4 (Hz)	10580.03	10378.29	10132.53	9968.70
f_5 (Hz)	15430.34	15592.03	15659.79	15693.52
f_6 (Hz)	22246.65	21760.07	21551.76	21454.86
f_7 (Hz)	25384.20	25560.93	25638.50	25674.15
f_8 (Hz)	34764.11	34399.54	34255.01	34188.85

Table 3.4. Effects of parameter R_0 on natural frequencies for $b_1=h_1=6/120$

	$R_0=50$ mm	$R_0=100$ mm	$R_0=150$ mm	$R_0=200$ mm
f_1 (Hz)	797.00	803.45	805.16	805.72
f_2 (Hz)	2930.13	2951.87	2990.30	3015.51
f_3 (Hz)	7133.35	7217.49	7267.87	7296.38
f_4 (Hz)	12720.34	12602.01	12392.65	12259.42
f_5 (Hz)	13710.32	13671.04	13680.67	13690.12
f_6 (Hz)	21633.21	21871.94	21967.59	22022.12
f_7 (Hz)	24084.31	23533.63	23312.78	23198.85
f_8 (Hz)	32110.80	32415.48	32528.06	32583.23

By using the numerical results given in Tables 3.2-4, different types of figures can be plotted. The first group plots are given in Figures 3.4-6 separately in the order of mode shapes, to see the effect of R_0 on the natural frequencies for three different values of taper parameters $b_1=h_1$ in the range of each natural frequency. The second group plots are given in Figure 3.7 to combine all the parameters in one plot.

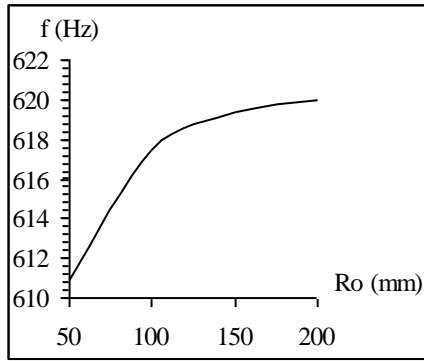

a) Natural frequency 1

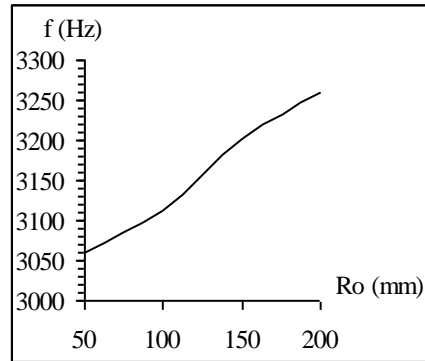

b) Natural frequency 2

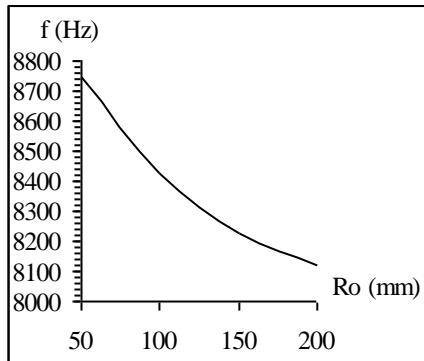

c) Natural frequency 3

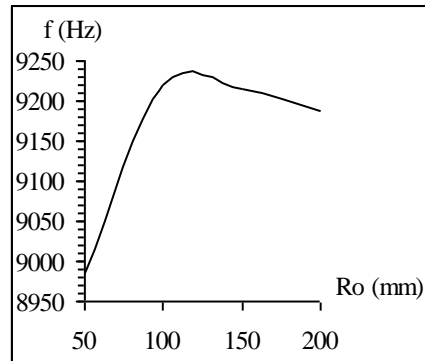

d) Natural frequency 4

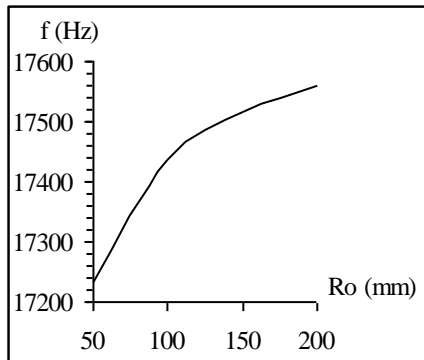

e) Natural frequency 5

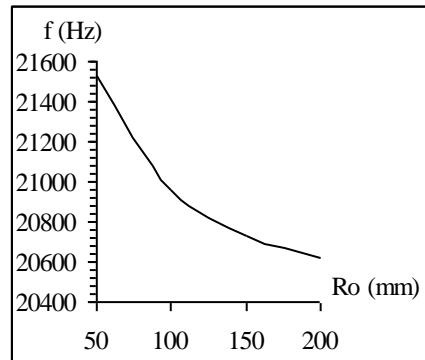

f) Natural frequency 6

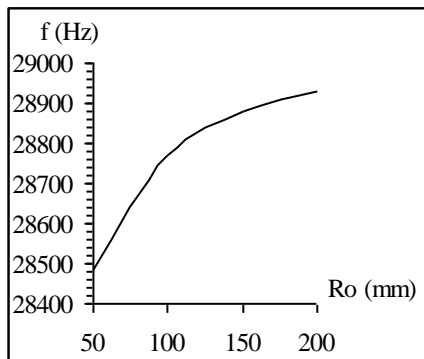

g) Natural frequency 7

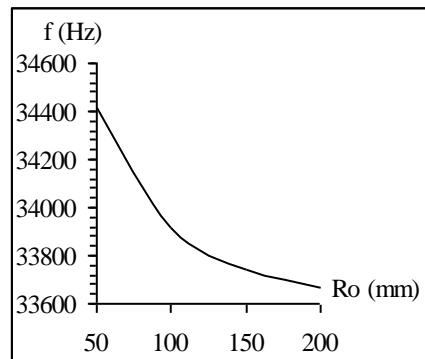

h) Natural frequency 8

Figure 3.4. Natural frequencies for $b_1=h_1=2/120$.

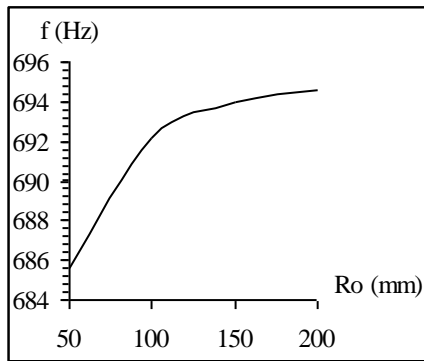

a) Natural frequency 1

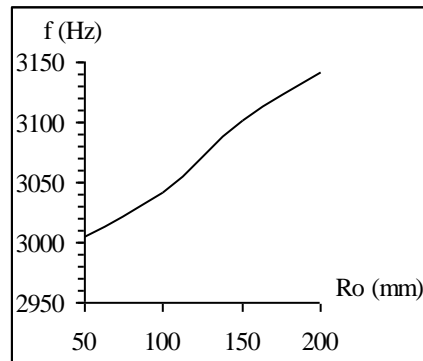

b) Natural frequency 2

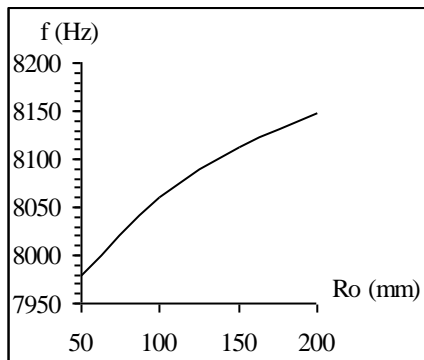

c) Natural frequency 3

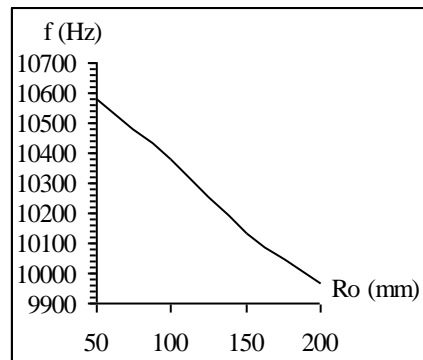

d) Natural frequency 4

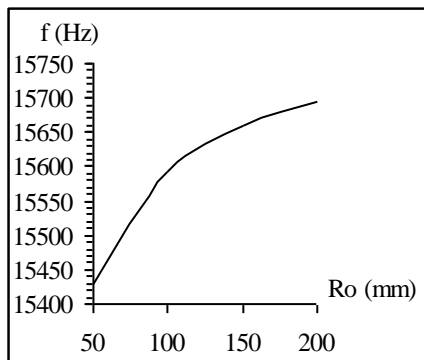

e) Natural frequency 5

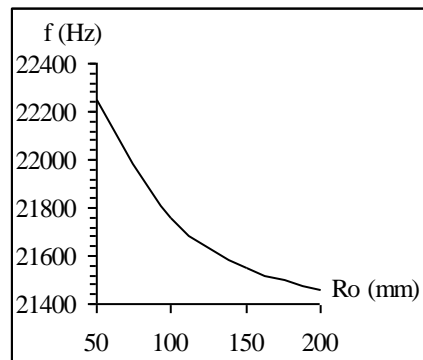

f) Natural frequency 6

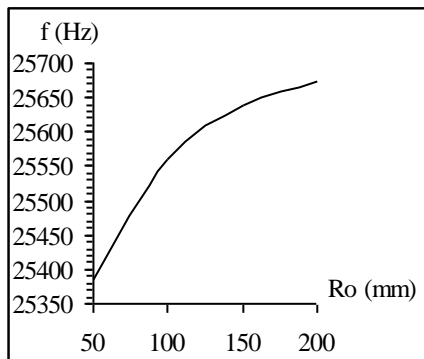

g) Natural frequency 7

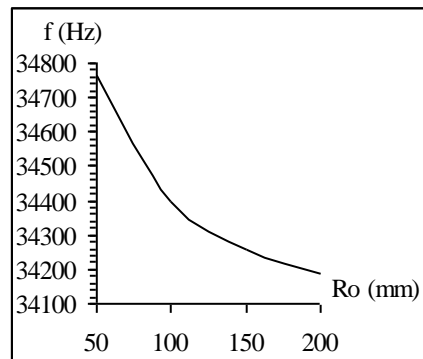

h) Natural frequency 8

Figure 3.5. Natural frequencies for $b_1=h_1=4/120$.

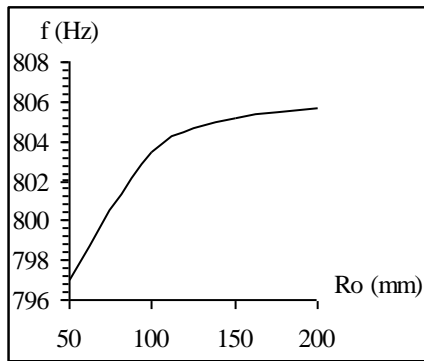

a) Natural frequency 1

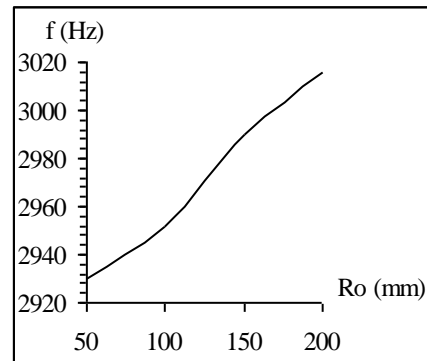

b) Natural frequency 2

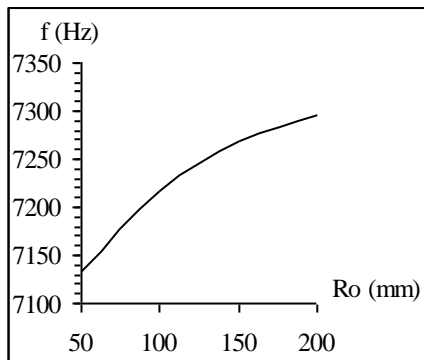

c) Natural frequency 3

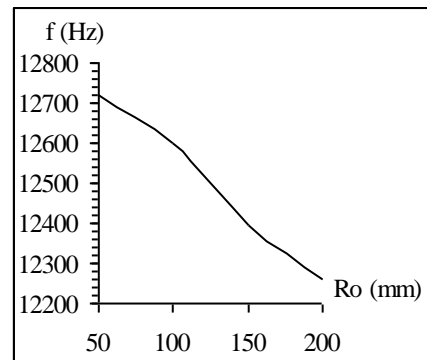

d) Natural frequency 4

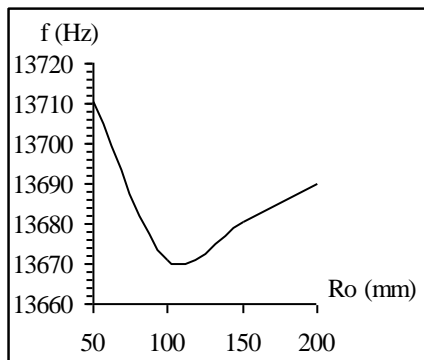

e) Natural frequency 5

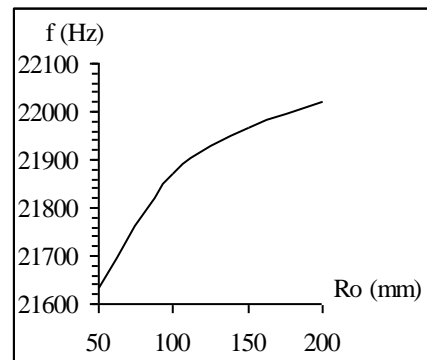

f) Natural frequency 6

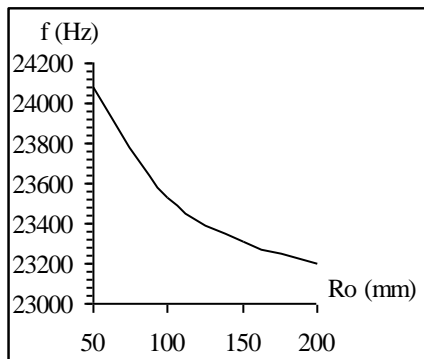

g) Natural frequency 7

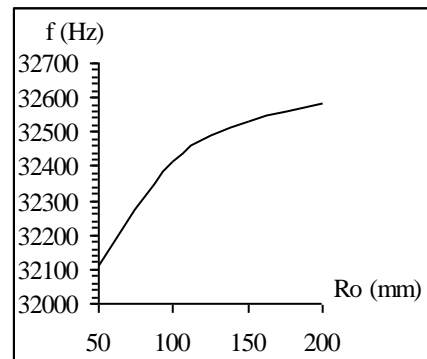

h) Natural frequency 8

Figure 3.6. Natural frequencies for $b_1=h_1=6/120$.

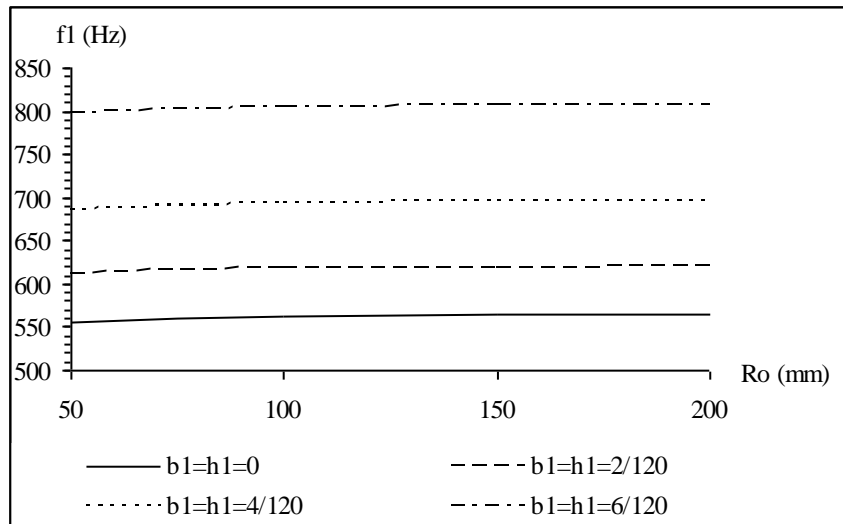

a) First natural frequencies

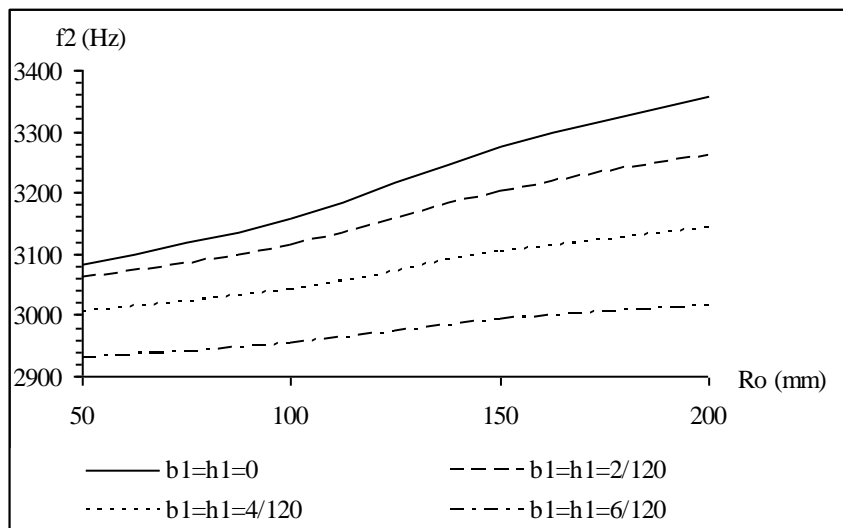

b) Second natural frequencies

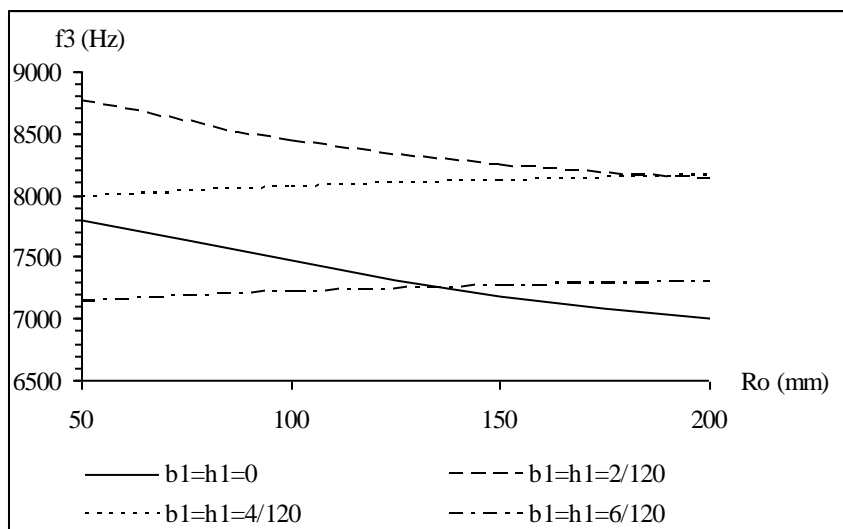

c) Third natural frequencies

Figure 3.7. Natural frequencies for different $b_1=h_1$ (cont. on next page)

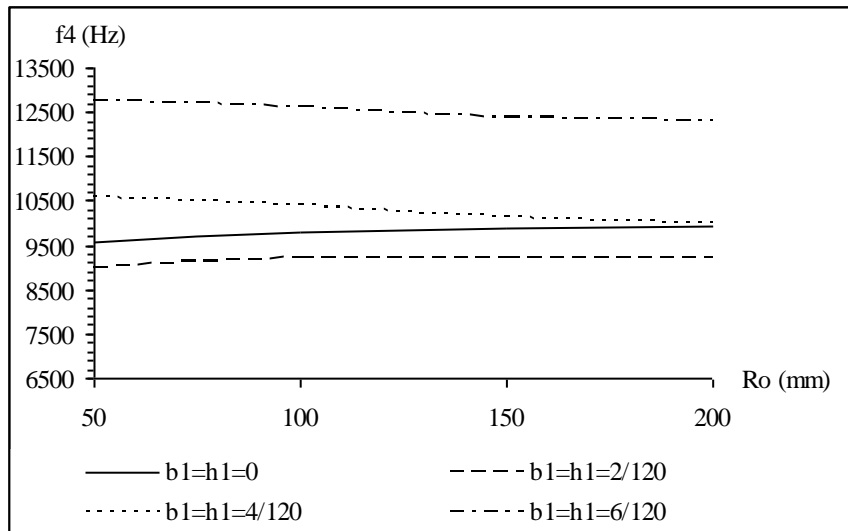

d) Fourth natural frequencies

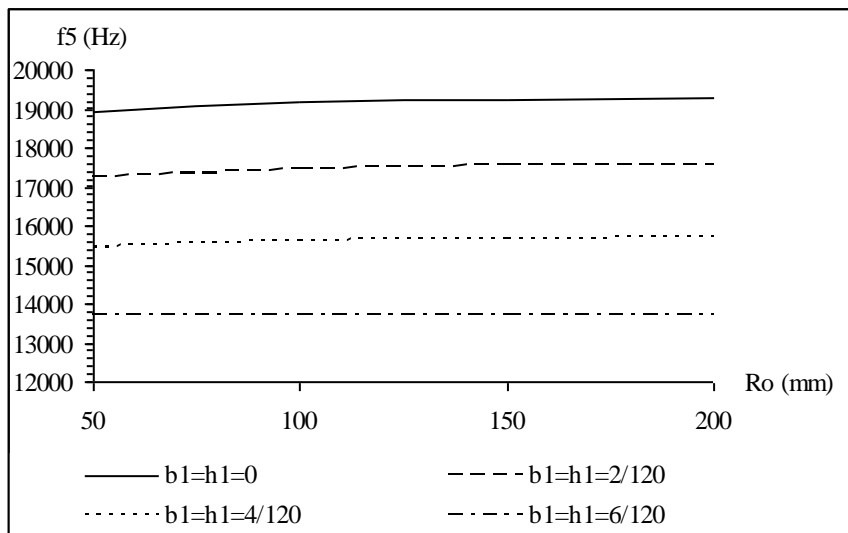

e) Fifth natural frequencies

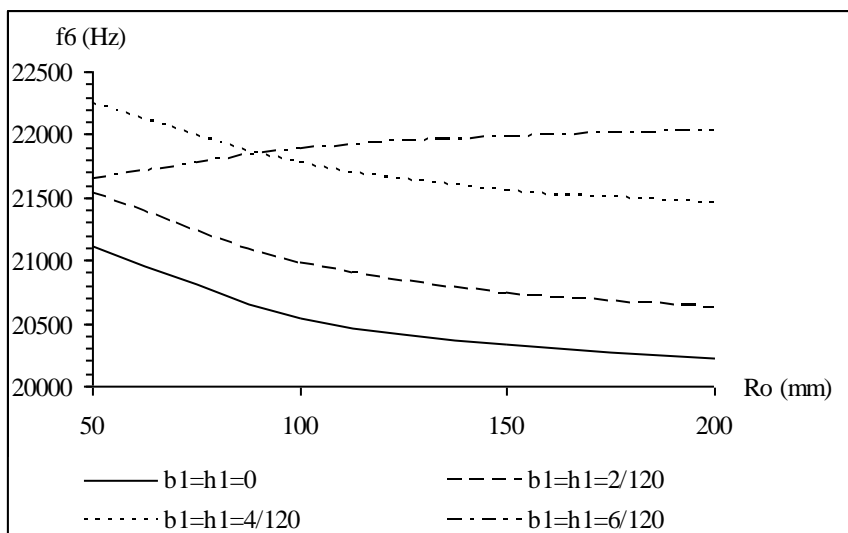

f) Sixth natural frequencies

Figure 3.7 (cont.)

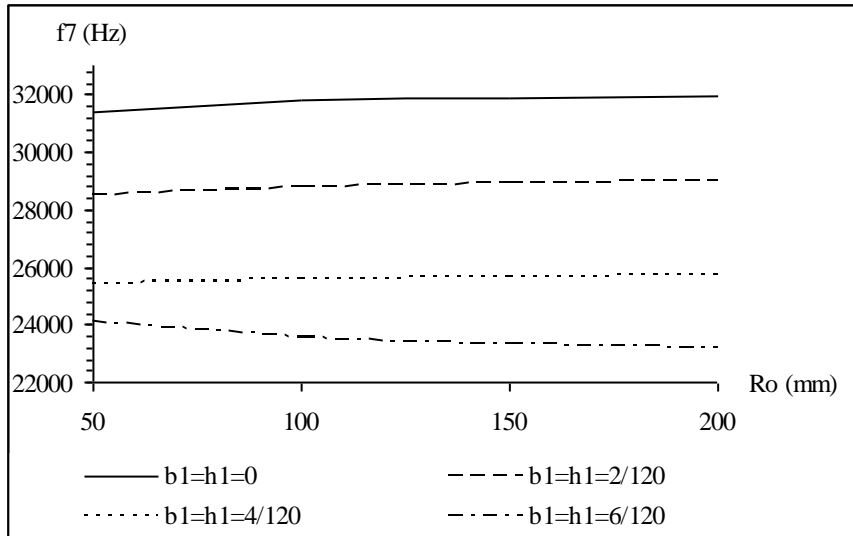

g) Seventh natural frequencies

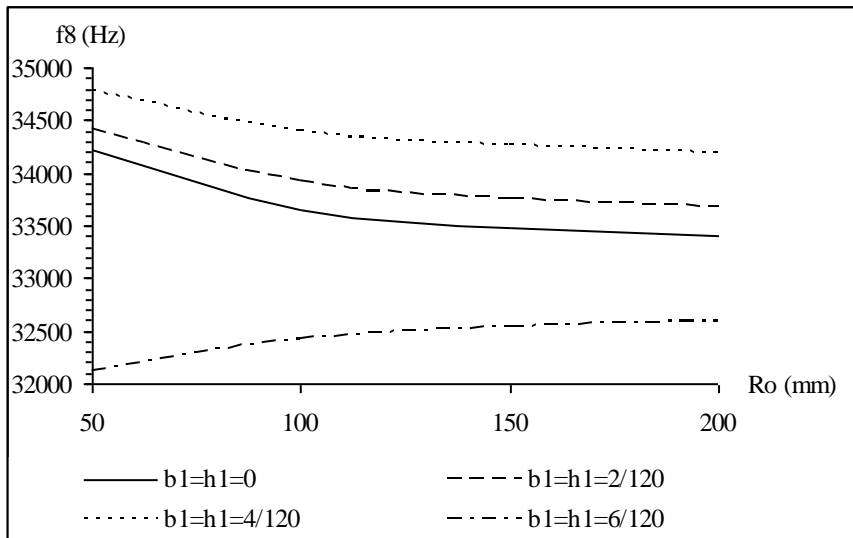

h) Eighth natural frequencies

Figure 3.7 (cont.)

It is clear that, due to the frequency range used in each plot in Figures 3.7.a-h, just effects of different tapering factors $b_1=h_1$ on natural frequencies can be discussed. It can be seen from Figures 3.7.a-h that there is no certain tendency depending on taper for all modes.

When the first two natural frequencies in Figures 3.7.a-b are examined, which are both belong to bending, the increase in the taper ratio leads to an increase in the first natural frequencies. However, for the second natural frequencies, aforementioned case is reversed.

Third natural frequencies that are the first torsional frequencies are plotted in Figure 3.7.c. In this figure, it is seen that for $b_1=h_1=0$ and $2/120$, natural frequencies are

decreased with the increasing of R_0 . On the contrary, this tendency is inverted for $b_1=h_1=4/120$ and $6/120$.

For the fourth natural frequencies, the effects similar to the third natural frequencies are also observed. But in this time, the decrease turns into an increase. The reason of this change is directly related to mode shapes. Third natural frequencies are related with torsional motion whereas fourth natural frequencies are bending motions.

Taper ratios affect the fifth natural frequencies in similar fashion with the increasing of R_0 .

Sixth natural frequencies that are the second torsional frequencies are plotted in Figure 3.7.f. It is partially similar to Figure 3.7.c. The only difference is the variation of natural frequencies with R_0 for the taper parameters $b_1=h_1=6/120$. It is similar for the curve for $b_1=h_1=0$.

Seventh natural frequencies are very similar to the second and the fifth natural frequencies. Taper effects are the same in these three groups.

Eighth natural frequencies that are the third torsional frequencies are plotted in Figure 3.7.h. The exceptional behavior can be seen for $b_1=h_1=6/120$.

Considering the all plots given in Figures 3.7.a-h, as the parameter R_0 increases, the effects of taper parameters become more important. It can be said that $R_0=100$ mm is a critical value since the tendency of some curves in these figures are changed sharply.

CHAPTER 4

CONCLUSIONS

In this study, the differential equations governing the free out-of plane vibrations of curved beams with variable curvature and variable cross-section are presented. The equations of motions are derived by using both Newtonian Method and the Hamilton's principle. Since the coefficients of the derived differential equations are not constant, it is not possible to express an exact solution.

For free vibration analysis, the coupled differential eigenvalue problem obtained by using separation of variables technique. It is reduced to discrete eigenvalue problem by using FDM (Finite Difference Method).

In the existing literature, for the free out-of-plane vibrations of curved beams, most of the researchers investigated the symmetrical boundary conditions such as both ends fixed, pinned or free conditions.

With this study, as far as the author is aware, for the first time, the natural frequencies for out-of plane vibrations of curved beams with variable curvature and variable cross-section as well as mode shapes are studied and presented for fixed-free condition.

In order to validate the developed computer program to solve the differential eigenvalue problem based on FDM, the solid models are created for Finite Element analysis. The results, found out from FDM, are compared with the results from FEM (Finite Element Method). Good agreement is obtained for lower modes.

The effects of taper and curvature parameters on natural frequencies are found for the linearly tapered curved beams in the shape of catenary with selected geometries.

REFERENCES

- Chang, T. and Volterra, E. 1969. Upper and lower bounds for frequencies of elastic arcs. *The Journal of the Acoustical Society of America* 46(5): 1165-1174.
- Hildebrand, Francis B. 1987. Introduction to numerical analysis. New York: Dover Publications.
- Huang, C. S., Tseng, Y. P. and Chang, S.H. 1998. Out-of-plane dynamic responses of non-circular curved beams by numerical laplace transform. *Journal of Sound and Vibration* 215: 407-424
- Huang, C. S., Tseng, Y. P., Chang, S.H. and Hung, C. L. 2000. Out-of-plane dynamic analysis of beams with arbitrarily varying curvature and cross-section by dynamic stiffness matrix method. *International Journal of Solids and Structures* 37: 495-513
- Irie, T., Yamada, G. and Takahashi, I. 1980. The steady state out-of-plane response of a Timoshenko curved beam with internal damping. *Journal of Sound and Vibration* 71: 145-156
- Kawakami, M., Sakiyama, T., Matsuda, H. and Morita, C. 1995. In-plane and out-of-plane free vibrations of curved beams with variable sections. *Journal of Sound and Vibration* 187: 381-401
- Kim, N. I., Seo, K. J. and Kim, M. Y. 2003. Free vibration and spatial stability of non-symmetric thin-walled curved beams with variable curvatures. *International Journal of Solids and Structures* 40: 3107-3128
- Lee, S. Y. and Chao, J. C. 2000. Out-of-plane vibrations of curved non-uniform beams of constant radius. *Journal of Sound and Vibration* 238: 443-458
- Lee, B. K., Oh, S. J., Mo, J. M. and Lee, T. E. 2008. Out-of-plane free vibrations of curved beams with variable curvature. *Journal of Sound and Vibration* 318: 227-246
- Love, Augustus E.H. 1944. A treatise on the mathematical theory of elasticity. New York: Dover Publications.
- Meirovitch, Leonard 1967. Analytical methods in vibrations. New York: Macmillan Publishing Co.
- Ojalvo, I.U. 1962. Coupled twist-bending vibrations of incomplete elastic rings, *International Journal of Mechanical Science* 4: 53-72
- Popov, E.P., Balan, T.A. 1998. Engineering Mechanics of Solids. New Jersey: Prentice Hall.

- Rao, Singiresu S. 2007. *Vibration of continuous systems*. New Jersey: John Wiley & Sons, Inc.
- Riley, K. F., Hobson, M. P. and Bence, S. J., 2006, *Mathematical Methods for Physics and Engineering*, New York: Cambridge University Press.
- Suzuki, K., Aida, H. and Takahashi, S. 1978. Vibrations of curved bars perpendicular to their planes. *Bulletin of the JSME* 21: 1685-1695
- Suzuki, K. and Takahashi, S. 1981. Out-plane vibrations of curved bars considering shear deformation and rotator inertia. *Bulletin of the JSME* 24: 1206-1213
- Suzuki, K., Kosawada, T. and Takahashi, S. 1983. Out-of-plane vibrations of curved bars with varying cross-section. *Bulletin of the JSME* 26:268-275
- Takahashi, S. and Suzuki K. 1977. Vibrations of elliptic arc bar perpendicular to its plane. *Bulletin of the JSME* 20: 1409-1416
- Tüfekçi, E. and Doğruer O. Y. 2006. Exact solution of out-of-plane problems of an arch with varying curvature and cross section. *Journal of Engineering Mechanics* 132: 600-609
- Volterra, E. and Morell, J. D. 1961. Lowest natural frequency of elastic arc for vibrations outside of the plane of initial curvature. *Journal of Applied Mechanics* 28: 624-627.
- Volterra, E. and Morell, J. D. 1961. Lowest natural frequency of elastic hinged arcs. *The Journal of the Acoustical Society of America* 33: 1787-1790
- Wang, T. M. 1975. Fundamental frequency of clamped elliptic arcs for vibrations outside the plane of initial curvature. *Journal of Sound and Vibration* 42: 515-519
- Yardimoglu, B. 2010. Dönen eğri eksenli çubukların titreşim özelliklerinin sonlu elemanlar yöntemi ile belirlenmesi. 2. Ulusal Tasarım İmalat ve Analiz Kongresi, Balıkesir, 514-522
- Yıldırım, V. 1997. In-plane and out-of-plane free vibration analysis of Archimedes-type spiral springs. *Journal of Applied Mechanics* 64:557-561