

# **DESIGN AND TECHNO-ECONOMIC ANALYSIS OF A SMART SOLAR GREENHOUSE**

**A Thesis Submitted to  
the Graduate School of  
Izmir Institute of Technology  
In Partial Fulfilment of the Requirements for the Degree of**

**MASTER OF SCIENCE**

**in Energy Engineering**

**by  
Didem İÇÖZ**

**July 2022  
İZMİR**

## ACKNOWLEDGEMENTS

I would like to thank and express my gratitude to my esteemed advisor, Assoc. Prof. Dr. Özgeç EBİL, who shared his valuable information with me in the realization of this study, spared his precious time for me whenever I consulted him, and did his best to be helpful with patience and great interest. Also, I would like to express my endless thanks to my co-supervisor Assist. Prof. Dr. Burak DİNDAROĞLU, who supported and guided me in terms of subject, source, and method in my work.

I would like to thank Prof. Dr. Gülden Gökçen AKKURT and the academicians of Izmir Institute of Technology Energy Engineering Department for their understanding and great support.

I would like to thank and express my gratitude to my family who always supported me, stood behind me and showed me the right path for my future.

Finally, I would like to express my endless thanks to my husband and colleague Emre İÇÖZ, who are my greatest luck in life, for the support and understanding he has shown throughout my studies.

# ABSTRACT

## DESIGN AND TECHNO-ECONOMIC ANALYSIS OF A SMART SOLAR GREENHOUSE

The aim of this study is to examine the combination of agriculture and energy, which are two indispensable concepts for the existence of humanity, more efficiently. Energy, which is an indispensable part of human life, is at the top of the issues discussed in the world agenda today as it was in the past. Energy continues to be an indispensable factor in the economic and social development of countries, and therefore in increasing social welfare.

With the developments in the agricultural sector, the energy need of the sector is increasing and energy diversity is important. In parallel with the world population, the demand for foodstuffs is increasing day by day. In order to meet this increasing food demand, greenhouse cultivation, where high efficiency is obtained from the unit area, is gaining more and more importance all over the world. Providing optimum conditions according to the location and seasonal characteristics of the location is essential for greenhouse efficiency. The need to heat greenhouses to provide these conditions constitutes a substantial energy cost. However, it is a known fact that fossil fuels, which are one of the energy sources, cause global climate changes, as they are an important source of CO<sub>2</sub>, known as a greenhouse gas. In this context, approaches to the use of renewable energy sources in agricultural activities are of great importance for the development of the sector. This study was prepared to examine the use and techno-economic analysis of photovoltaic panels for the energy needs of greenhouses. The solar greenhouse, where optimum conditions are provided with the automation system, will generate income from electricity sales as well as agricultural income in the months when it produces more electricity than its self-consumption.

**Keywords:** Photovoltaic Greenhouses, Solar Sector, Photovoltaic Applications, Environmental Awareness

# ÖZET

## FOTOVOLTAİK AKILLI SERA TASARIMI VE TEKNO-EKONOMİK ANALİZİ

Bu çalışmanın amacı, insanlığın varoluşu için vazgeçilmez iki kavram olan tarım ve enerjinin daha verimli halde bir araya gelmesini incelemektir. İnsan yaşamının vazgeçilmez bir parçası olan enerji, geçmişte olduğu gibi bugün de dünya gündeminde tartışılan konuların başında yer almaktadır. Enerji, ülkelerin ekonomik ve sosyal olarak gelişiminde, dolayısıyla toplumsal refahın artırılmasında vazgeçilmez bir etken olmaya devam etmektedir.

Tarım sektöründeki gelişmelerle birlikte, sektörün enerji ihtiyacı artmakta ve enerji çeşitliliği önem arz etmektedir. Dünya nüfusuna paralel olarak gıda maddelerine olan talep de her geçen gün artış göstermektedir. Artan gıda talebinin karşılanması için, birim alandan yüksek verimin alındığı seracılık, tüm dünyada her geçen gün daha fazla önem kazanmaktadır. Bulunduğu lokasyona ve lokasyonun mevsimsel özelliklerine göre optimum koşulların sağlanabilmesi sera verimliliği için zorunludur. Bu koşulların sağlanabilmesi için seraları ısıtma ihtiyacı azımsanamayacak bir enerji maliyetini oluşturmaktadır. Ancak enerji kaynaklarından biri olan fosil yakıtların sera gazı olarak bilinen CO<sub>2</sub>'nin önemli kaynağı olması sebebiyle, küresel iklim değişikliklerine neden olduğu da bilinen bir gerçektir. Bu kapsamda yenilenebilir enerji kaynaklarının tarımsal faaliyetlerde kullanımına yönelik yaklaşımlar sektörün gelişimi açısından büyük öneme sahiptir. Bu çalışma, fotovoltaik panellerin, seraların enerji ihtiyacı için kullanımını ve tekno-ekonomik analizini incelemek için hazırlanmıştır. Otomasyon sistemiyle optimum koşulların sağlandığı solar sera, öztüketiminden fazla elektrik ürettiği aylarda ise tarımsal kazancın yanında elektrik satışından da gelir elde edecektir.

**Anahtar Kelimeler:** Fotovoltaik Seralar, Solar Sektör, Fotovoltaik Uygulamalar, Çevre Duyarlılığı

# TABLE OF CONTENTS

LIST OF FIGURES .....	vii
LIST OF TABLES.....	ix
CHAPTER 1. INTRODUCTION .....	1
CHAPTER 2. AIM OF THE STUDY .....	3
2.1. Greenhouse in the World.....	4
2.2. Agriculture And Greenhouses in Turkey.....	7
2.3. Renewable Energy in Greenhouses .....	12
2.4. Solar Energy in Turkey.....	13
2.5. Renewable Energy Regulation .....	18
CHAPTER 3. GREENHOUSE INSTALLATION .....	20
3.1. Construction.....	22
3.1.1. Base .....	23
3.1.2. Columns .....	23
3.1.3. Clippers .....	24
3.1.4. Rain Gutters.....	24
3.1.5. Connectors.....	25
3.2. Air Conditioning.....	25
3.3. Ventilation .....	27
3.4. Automatic Irrigation and Fertilization.....	28
3.5. Automation Systems.....	29
3.6. Energy Calculation for Example Greenhouse .....	30
CHAPTER 4. SOLAR PANEL DESIGN IN PV GREENHOUSE .....	41
4.1. Solar Panel Design for the Eastern Anatolia Region.....	42
4.2. Solar Panel Design for the Mediterranean Region.....	45
CHAPTER 5. TECHNO-ECONOMIC ANALYSIS .....	47
5.1. Economic Analysis of Solar Greenhouse .....	48

5.1.1. Economic Analysis and Parameters Used.....	48
5.1.2. Sensitivity Analysis.....	58
5.1.3. Electricity Generation Uncertainty.....	64
5.2. Economic Analysis of Greenhouse Investment Without PV.....	66
5.2.1. Sensitivity Analysis of Greenhouse Investment Without PV .....	69
CHAPTER 6. CONCLUSION .....	74
REFERENCES .....	77

GCPRIS

# LIST OF FIGURES

<b><u>Figure</u></b>	<b><u>Page</u></b>
Figure 2.1. Change of Greenhouse Areas in Turkey Between 1995-2019 .....	9
Figure 2.2. Turkey Solar Radiation Map .....	14
Figure 2.3. Distribution of Turkey's 2019 Installed Power by Resources .....	16
Figure 2.4. Distribution of Turkey's 2019 Installed Power by Solar Energy .....	17
Figure 3.1. Front View of Sample Greenhouse Design.....	23
Figure 3.2. Top View of Sample Greenhouse Design .....	23
Figure 3.3. Columns of Sample Greenhouse Design.....	24
Figure 3.4. Shears of Sample Greenhouse Design.....	24
Figure 3.5. Rain Gutters of Sample Greenhouse Design.....	25
Figure 3.6. Irrigation System and Filter Systems for Sample Greenhouse Design .....	28
Figure 3.7. Automation Schema for Sample Greenhouse Design .....	29
Figure 3.8. Dimensions And Schematic View of The Sample Greenhouse Design.....	31
Figure 4.1. Grid Connect Photovoltaic System Diagram .....	42
Figure 4.2. Annual Loss Diagram.....	44
Figure 4.3. Normal Production and Loss Factors .....	44
Figure 4.4. Annual Loss Diagram.....	46
Figure 4.5. Normal Production and Loss Factors .....	46
Figure 5.1. Sensitivity Analysis: Net Present Value & Electricity Price for the Mediterranean Region.....	60
Figure 5.2. Sensitivity Analysis: Net Present Value & Tomato Price for the Mediterranean Region.....	61
Figure 5.3. Sensitivity Analysis: Net Present Value & Electricity Price for the Eastern Anatolia Region .....	62
Figure 5.4. Sensitivity Analysis: Net Present Value & Tomato Price for the Eastern Anatolia Region .....	64
Figure 5.5. Sensitivity Analysis: Net Present Value & Electricity Price for the Mediterranean Region.....	69
Figure 5.6. Sensitivity Analysis: Net Present Value & Tomato Price for the Mediterranean Region.....	70

<b><u>Figure</u></b>	<b><u>Page</u></b>
Figure 5.7. Sensitivity Analysis: Net Present Value & Electricity Price for the Eastern Anatolia Region .....	71
Figure 5.8. Sensitivity Analysis: Net Present Value & Tomato Price for the Mediterranean Region.....	73

GCPRIS

## LIST OF TABLES

<b><u>Table</u></b>	<b><u>Page</u></b>
Table 2.1. Agricultural Fields in Turkey .....	8
Table 2.2. Status of Greenhouse Agricultural Lands in Turkey According to Their Characteristics Between 1995-2019.....	11
Table 2.3. Products Grown in Greenhouse in 2019 .....	12
Table 2.4. Distribution of Turkey's Total Solar Energy Potential by Month .....	15
Table 2.5. Radiation Values and Sunning Times of Regions in Turkey .....	15
Table 3.1. Technical Specifications of The Sample Greenhouse .....	21
Table 3.2. Monthly Heating Energy Requirement for The Sample Greenhouse Design in The Eastern Anatolia Region .....	39
Table 3.3. Monthly Heating Energy Requirement for The Sample Greenhouse Design in The Mediterranean Region .....	39
Table 3.4. Monthly Energy Requirement for The Sample Greenhouse Design in The Eastern Anatolia Region .....	40
Table 3.5. Monthly Energy Requirement for The Sample Greenhouse Design in The Mediterranean Region.....	41
Table 4.1. Photovoltaic Modules in Design.....	43
Table 4.2. Inverters in the Design.....	43
Table 4.3. Photovoltaic Modules in Design.....	45
Table 4.4. Inverters in the Design.....	45
Table 5.1. MARR & Corporate Income Tax .....	49
Table 5.2. Electricity Price .....	49
Table 5.3. Cost Summary for the Mediterranean and Eastern Anatolia Regions.....	50
Table 5.4. Revenue Summary for the Mediterranean Region .....	52
Table 5.5. Cost Summary for the Mediterranean Region .....	53
Table 5.6. Revenue Summary for the Eastern Anatolia Region.....	54
Table 5.7. Cost Summary for the Eastern Anatolia Region.....	55
Table 5.8. IRR and MARR Comparison for the Mediterranean Region .....	56
Table 5.9. IRR and MARR Comparison for the Eastern Anatolia Region.....	56
Table 5.10. Return on Investment for the Mediterranean and Eastern Anatolia Regions .....	57

<b><u>Table</u></b>	<b><u>Page</u></b>
Table 5.11. NPV Calculation According to MARR for the Mediterranean Region.....	58
Table 5.12. NPV Calculation According to MARR for the Eastern Anatolia Region ...	58
Table 5.13. Sensitivity of Net Present Value to Electricity Price for the Mediterranean Region.....	61
Table 5.14. Sensitivity of Net Present Value to Tomato Price for the Mediterranean Region.....	62
Table 5.15. Sensitivity of Net Present Value to Electricity Price for the Eastern Anatolia Region .....	63
Table 5.16. Sensitivity of Net Present Value to Tomato Price for the Eastern Anatolia Region .....	64
Table 5.17. Electricity Generation Uncertainty for the Mediterranean Region.....	65
Table 5.18. Electricity Generation Uncertainty for the Eastern Anatolia Region .....	66
Table 5.19. Cost Summary for the Mediterranean and Eastern Anatolia Regions.....	67
Table 5.20. Return on Investment for the Mediterranean and Eastern Anatolia Regions .....	67
Table 5.21. NPV Calculation According to MARR for the Mediterranean Region.....	68
Table 5.22. NPV Calculation According to MARR for the Eastern Anatolia Region ...	68
Table 5.23. Sensitivity of Net Present Value to Electricity Price for the Mediterranean Region .....	70
Table 5.24. Sensitivity of Net Present Value to Tomato Price for the Mediterranean Region.....	71
Table 5.25. Sensitivity of Net Present Value to Electricity Price for the Eastern Anatolia Region.....	72
Table 5.26. Sensitivity of Net Present Value to Tomato Price for the Eastern Anatolia Region.....	73

# CHAPTER 1

## INTRODUCTION

The need for energy in Turkey and the world is constantly increasing. The fossil fuel resources used to meet this need are rapidly depleting. Moreover, due to the negative effects of fossil fuel use, ambient temperatures on the planet rise, glaciers melt, and natural disasters occur. In addition, people, animals, and plants suffer greatly due to the negative effects of soil, water, and air pollution. Parallel to all these negativities, the food supply is increasing day by day with the increasing population. As a result of soil pollution caused by the use of fossil fuels for energy needs, agricultural conditions made with traditional methods have become unfavorable. Increasing energy needs and food supply; led to the integration of technology and renewable energy sources with agriculture. In recent years, agricultural lands that have become unproductive have started to leave their place for greenhouses. To provide the most suitable conditions for the growth and development of plants by controlling temperature, humidity, radiation, carbon dioxide, and air movement when necessary, without being completely or partially dependent on climatic environmental conditions, outside of the normal open growing seasons of cultivated plants such as vegetables, fruits and flowers, and “greenhouse” for structures covered with a light-permeable covering material to produce their seeds, seedlings, and saplings; Plant production in greenhouses is called “greenhouse”. Greenhouse cultivation is generally considered a sub-branch of the general category of fresh fruit and vegetable production (Sevgican et al. 2000). Various methods are used to eliminate the negativities in product cultivation, make production sustainable with minimum damage, and provide a growing environment for each product every month of the year. Growing products in greenhouses are one of them. Greenhouse cultivation, which is a more profitable branch of agriculture as a result of higher yield, quality, and early product production, which allows plant production throughout the year, is of great importance. When done in place and correctly, the profitability rate of greenhouse agriculture is quite high compared to other agricultural practices. A significant part of the agricultural products, which have a large share in the exports made by our country, are provided in greenhouses (Özkan and Yılmaz 1999).

However, greenhouse cultivation is more expensive than traditional agricultural production methods in terms of operating and setup costs and requires more technical knowledge and skills. Heating greenhouses, especially in the cold winter months, is a dramatic expense for the greenhouse business, both in terms of investment cost and as an expense item. The integration of greenhouse cultivation with developing technology and renewable energy sources is a serious step to eliminate this big problem. Although greenhouses that produce their energy from renewable sources and whose indoor conditions can be controlled with maximum automation are high in terms of investment costs, they will become a profitable enterprise in a short time due to current energy costs and food supply. Renewable energy sources do not cause environmental problems, do not threaten the lives of living things, are clean, reliable, and sustainable, and are of great importance for the future of human beings. Being a self-sufficient country in terms of energy and food supply, Turkey, plays an important role in eliminating the dependency on other countries. It is obvious that with the implementation of properly designed and techno-economically applicable greenhouse practices, the added value provided by greenhouse cultivation will increase exponentially, and as a result of these developments, in the region where greenhouse cultivation is carried out, significant benefits will be provided for the welfare of the people of the region.

Solar energy, which is included in renewable energy sources, is an inexhaustible source of energy and has a very low CO<sub>2</sub> release, moreover, carbon monoxide, sulphur, smoke, gas, radiation, etc. It also does not have environmental pollutants. It can be used safely for different energy needs. Solar energy has no irritating elements such as smells or sounds (Gürbüz 2009). Turkey is a very lucky country in the production of electricity from solar energy. Thanks to its geographical location, it is a very rich country in terms of solar energy potential (Avcıoğlu, Dayıoğlu, and Türker 2019). By making maximum use of these resources, it will be possible to provide great support to energy supply security, eliminate or reduce dependence on foreign resources due to fossil fuels as much as possible, and create new employment areas. The aim of this study, prepared in this direction, is to reveal the use of solar energy in greenhouse activities and its economic analysis. In addition, contributing to the awareness of the agricultural sector about solar energy for greenhouse activities and the development of energy policies in our country and a more effective way of renewable energies are also included in these objectives.

## CHAPTER 2

### AIM OF THE STUDY

Agriculture is a lifestyle and economic activity that directly affects the economic and social life in our country and shapes social life. In this context, agriculture is undergoing an industrialization evolution that is subject to trade and competition. With the developments in the agricultural sector, the energy need of the sector is increasing and energy diversity is important.

In parallel with the rapidly increasing world population, the demand for foodstuffs is increasing day by day. People often want to consume vegetables and fruits out of season. To meet this increasing food demand and to meet the demand for vegetables and fruits out of season, greenhouse cultivation, where high yields are obtained from the unit area, is gaining more and more importance all over the world. Greenhouses are facilities where production is made by providing the most suitable environmental conditions for plant growth. Providing optimum conditions (temperature, humidity, oxygen, and carbon dioxide amount, light, water, etc.) according to the location and seasonal characteristics of the location is essential for greenhouse efficiency, and providing these conditions constitutes a substantial energy cost. In this context, approaches to the use of renewable energy resources in agricultural activities are of great importance for the development of the sector.

This study has been prepared to examine the use of photovoltaic panels in greenhouse activities and their techno-economic analysis. The construction, air conditioning, ventilation, automatic irrigation, and automation systems that will provide control of all are designed according to the existing operating conditions for two separate greenhouses with the same characteristics, located in the Eastern Anatolia and Mediterranean regions of Turkey. In addition, the analyzes of greenhouse heat loss and heating need, which are large cost items, were made for both regions. The methods and calculations followed in the analysis and processes are introduced for the sample greenhouse design. In order to make a greenhouse can, that can be self-sufficient, a grid-connected (on-grid) photovoltaic system was designed. So, the electricity production will match up with self-consumption with renewable energy. In addition to

the need for heating, which is a serious item for electricity consumption in winter, other electricity consumption items are met by photovoltaic panels and from the grid if needed; With the method of offsetting with the distribution company according to the region where the greenhouse is located, the electricity self-consumption of which decreases in the summer months when there is no heating; It is predicted that the annual total electricity costs will decrease by printing the generated electricity to the network through the bidirectional meter. Projection calculations were carried out by making economic analysis and market research for both regions of the greenhouse designed with photovoltaic panels.

## **2.1. Greenhouse in the World**

The growth trend of consumption due to the increase in the human population in the world, together with the increasing demand, creates great pressure on agricultural systems and natural resources. Therefore, the food supply has become one of the greatest challenges humanities has to overcome in the twenty-first century. Agricultural activities are the main food providers. Today, around 275 million hectares worldwide are devoted to irrigated crops, and this area is growing at an average annual rate of 1.3%. To meet the food demand in 2050, world production must increase by 70%. This predicted increase in food production means expansion of cultivated agricultural lands or intensification of production in agricultural lands. In this context, with the realization of the scenarios in 2050, a 53% increase in the consumption of water resources will be required. The disadvantage of the increase in the foreseen agricultural activities is the consequences that necessitate the transformation of land uses and cause losses in the natural ecosystem. This will bring along global threats such as water scarcity and damage to biodiversity. With the Food and Agriculture Organization Declaration on the need to increase production in order to nutritional needs of the increasing population in 2050, the term "sustainable concentration" started to come to the fore in 2008 (Vermeulen, S. 2014). It is understood that the main goal to be pursued with the new term is to increase the food supply with less pressure on the natural environment. Sustainable intensification is a goal, and a universal and promising alternative to achieve it is greenhouse cultivation. In recent years, the intensification of greenhouse agriculture in the world has increased production and met the demand. The greenhouse

industry is constantly developing new strategies and technologies to solve some of the limitations of crops, reduce environmental impacts, and adapt to new market requirements. For this reason, products that can be grown without soil, the control of the factors that create the micro-scale climate in the greenhouse, the creation of vertical systems that can be located in urban environments, and the development of sustainable solutions to ensure the integration of renewable energy into production in the greenhouse; The development of new materials and structures that can optimize production is now on the agenda of the world's agriculture sector.

Although greenhouses have existed since the 1800s and greenhouse food production began to develop as an industry in the second half of the nineteenth century, the biggest growth and expansion of the greenhouse industry was during World War II (Avcıoğlu, Dayıoğlu, and Türker 2019). It happened around the world after World War II. Today, food production in greenhouses can be found on all continents. The most popular food crops grown in greenhouses are tomatoes, cucumbers, and sweet peppers. Other greenhouse-grown vegetables include watermelon, cantaloupe, summer squash, zucchini, lettuce, eggplant, baked beans, celery, cabbage, radishes, Welsh onions, and asparagus. In addition to fruits such as grapes, strawberries, bananas, pineapples, papayas, oranges, tangerines, cherries, and figs, medicinal plants are also grown in greenhouses (Eltez and Öztekin 2011). The main greenhouse cover materials are glass and polyethylene. Glass has been used since the first appearance of greenhouses. In addition, polyethylene film, II. Since World War II, it has become a widely used coating material in greenhouse production in the world. Glass-covered greenhouses are generally concentrated in Northern Europe and North America. Although the low cost of the polyethylene greenhouse is the main reason for its high popularity, especially in developing countries, the use of polyethylene film has spread to the northern regions in recent years. Studies have shown that under Canadian climatic conditions, the heating costs of a double-layered polyethylene greenhouse are 20% to 30% lower than a glass-covered greenhouse (Eltez and Öztekin 2011). Standard polyethylene film blocks ultraviolet rays; however, it does not block infrared radiation and is short-lived. However, the improved polyethylene films, in addition to protecting the infrared, allow the ultraviolet rays, which are used for pollination of plants and necessary for the bees to orient themselves, to enter the greenhouse and are more durable. Polyvinyl chloride, another plastic film used to cover greenhouses, is mostly used in Japan. Other covering

materials for greenhouses include rigid plastic acrylic, fiberglass, polycarbonate, and polyvinyl chloride panels, but their use is not very common due to their high cost compared to polyethylene.

It is possible to classify the countries where greenhouse cultivation is carried out, considering the location and different greenhouse technologies, as follows.

1. Countries in the cool climate zone,
2. Countries in the temperate climate zone,
3. Countries dominated by two climates.

The main European countries in the cool climate zone are the Netherlands, England, Denmark, Germany, Romania, Bulgaria, and Russia. The Netherlands is the leading country among these countries in terms of greenhouse area and production techniques. The common features of these countries in terms of greenhouse cultivation are as follows:

- Greenhouse structural elements are made of profile steel, aluminum, or another alloy, and cover materials are glass.
- Greenhouse construction and installation of heating systems require a high investment.
- Climatic factors necessitate long-term heating in the greenhouse.
- In these greenhouses, the most suitable heating, lighting, ventilation, and other cultural processes are carried out completely.

The greenhouse enterprises of the countries in the cool climate zone struggle with difficulties such as higher production costs, higher energy costs and not increasing the product variety compared to the greenhouse enterprises in the temperate climate zone.

The favorable ecological conditions of the countries in the temperate climate zone enable profitable greenhouse cultivation. Greenhouse areas are increasing rapidly in these countries, especially in winter, due to the high average temperature and the reduction of heating costs, which is the biggest cost in greenhouses. There are countries with a coast to the Mediterranean in the temperate climate zone. Countries such as Spain, Turkey, Italy, Greece, and Israel are in this belt. In terms of greenhouse activities of the countries in this belt; They have common features such as being able to be made in two crops as spring and autumn cultivation, being able to be established with low investment costs, keeping the heating, which is the biggest operating expense, at the

lowest level. Despite the low investment and operating costs, the production technologies in greenhouses in these countries are low and the yield and quality of the products obtained from the greenhouses are lower.

Spain, the Netherlands, Italy, Belgium, Egypt, Morocco, and China are the main countries in two climate zones with an annual average (sea level) of 0°C to 20°C. In countries where both climates are dominant, the common feature is the combination of glass and plastic greenhouses. Although greenhouses in Mediterranean countries have this feature, advanced technology is also applied to plastic greenhouses in the USA and Japan in these countries.

## **2.2. Agriculture And Greenhouses in Turkey**

Turkey, which has opened its doors to various civilizations throughout history, is an ancient center of world trade due to its geographical location. The fact that the climate differs according to the regions has contributed to the agricultural activities in many areas and types. After the settled life during the Seljuk Empire, agriculture became an important source of income for the population. While a large part of the people was doing field agriculture, another part of them was engaged in fruit production and viticulture. In the period of the Ottoman Empire, about 90% of the population made a living by doing agricultural activities. While 90% of the total agricultural production consists of cereals, rice, cotton, hemp, tobacco, viticulture, vegetable, and fruit production are among the important agricultural activities. In 1913, beet production started with the import of sugar beet seeds. In the first years of the Republic, the agricultural sector was determined as the sector that would provide development as a country, and policies aimed at increasing agricultural production were followed. The developments between 1923 and 1929 showed that the election was successful. Between these years, a growth of more than 10% was achieved in the agricultural sector. In the 1930s, Agricultural Credit and Sales Cooperatives, Agricultural Combines, and State Agricultural Enterprises were established in Turkey in order to support agricultural activities. As a result of the negative effects of the Second World War in the 1940s, the prices of agricultural products increased continuously. During this period, the increase in the prices of agricultural products was tried to be reduced and enacting the Farmer Landing Law in 1945, was aimed to land the farmers who do not have land.

By the 1950s, however, the expected result from the land reform could not be achieved, as migration from rural areas to cities began. After the 1960s, 5-year development plans were prepared and policies supporting agricultural activities were adopted, and the increase in production in the agricultural sector continued with the preparation of development plans (Table 2.1).

Table 2.1. Agricultural Fields in Turkey  
(TUIK 2019)

<b>Farming areas</b>	<b>1990 (1000 ha)</b>	<b>2002 (1000 ha)</b>	<b>2016 (1000 ha)</b>	<b>2017 (1000 ha)</b>	<b>2018 (1000 ha)</b>	<b>2019 (1000 ha)</b>
<b>Farm plants</b>	18,868	17,935	15,575	15,532	15,421	15,387
<b>Fallow</b>	5,324	5,040	3,998	3,697	3,513	3,387
<b>Vegetable</b>	635	930	804	798	784	790
<b>Fruit, Spices</b>	3,029	2,674	3,329	3,343	3,457	3,525
<b>Ornamental Plants</b>	-	-	5	5	5,1	5,2
<b>TOTAL</b>	27,856	26,576	23,711	23,375	23,180	23,094

The agricultural production value of Turkey in 2019 is 195,831,756,990 TL. Turkey is an exporter country in foreign trade of agricultural products, and in 2019 it made 17,958 M\$ of agricultural exports and in return, it made 12,653 M\$ of agricultural imports (Özkan and Yılmaz 1999).

In parallel with the rapidly increasing population, the demand for foodstuffs is increasing day by day. Nowadays, people often want to consume fruits and vegetables out of season. To meet the increasing food demand and to meet the demand for fruit and vegetables out of season, greenhouse cultivation, where high yields are obtained from the unit area, is gaining more and more importance in Turkey as well as in the whole world. Greenhouse farming has a great contribution to the economy in Turkey in terms of diversity in agriculture, employment, and increasing the agricultural population. When done in place and correctly, the profitability rate of greenhouse agriculture is higher than other agricultural applications. Considering the existence and productivity of soil in Turkey, greenhouse cultivation; is one of the important factors that reducing

employment, ensures that more products are obtained from the unit area and makes agricultural activities in rural areas more income-generating, thus reducing the rate of economic-based rural-urban migration. Greenhouse cultivation in Turkey started with the establishment of experimental greenhouses in Antalya and Mersin in the 1940s. However, greenhouse areas did not increase much until the 1960s. The beginning of the use of plastic in agriculture in the early 1960s was a turning point for the greenhouse sector as the initial investment cost decreased. Thus, it has become one of the most important agricultural activities in Turkey over time (Figure 2.1).

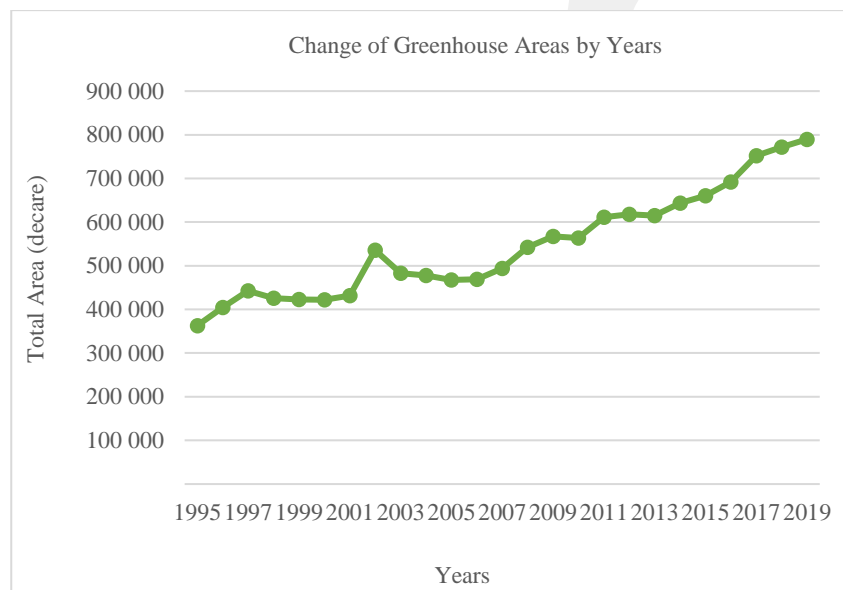

Figure 2.1. Change of Greenhouse Areas in Turkey Between 1995-2019 (Source: TUIK 2019)

It is seen that Turkey’s total greenhouse assets reached 363,042 decare in 1995. In the last 25 years, greenhouse areas, which have accelerated, even more, have increased by 117.5%. This rate of increase highlights the importance of the greenhouse sector for Turkey.

Greenhouse cultivation in Turkey shows distribution and development on the Marmara, Aegean, and Mediterranean coastlines. Within this distribution, there are intense production areas in places. Greenhouse cultivation around Yalova in the north is concentrated around İzmir and Muğla in the west, around Antalya and Mersin in the south, and extends from there to Hatay. The biggest problem in greenhouse management in Turkey is providing the most suitable temperature for the development of the plant in the greenhouse. Since the heating systems and maintenance costs used for

this purpose increase the cost, the regions where greenhouse operations can be established are concentrated in the Mediterranean, Aegean, Marmara, and the Black Sea regions with temperate climates. The value of greenhouse crop production in Turkey is approximately 10 billion TL. Antalya ranks first in greenhouse vegetable production with a share of 48% (3.8 million tons). Antalya is followed by Mersin 16% (1.2 million tons), Adana 13% (1 million tons), and Muğla 9% (690 thousand tons). Turkey's greenhouse production in these 4 provinces is approximately 6.7 million tons, which constitutes approximately 86% of Turkey's total greenhouse production (Özkan and Yılmaz 1999).

When classified in terms of the techniques used in the greenhouse industry, we come across low tunnels, high tunnels, and greenhouses (glass and plastic). Low tunnels, glass, plastic, etc. is a high-system greenhouse cultivation structure made in different ways by covering with light-permeable material. High tunnels allow people to enter easily and allow agricultural mechanisms; However, they are narrow and semi-circular cross-section structures that do not usually have heating and ventilation systems. All these cover types are plastic covers. Greenhouses, on the other hand, are covered structures that can allow the control of all climate elements. Greenhouse cultivation is the use of glass, plastic, etc. to produce various cultivated plants and their seeds, seedlings, and saplings throughout the year, to protect and display the plants, by keeping factors such as temperature, light, humidity, and air under control, regardless of climate-related environmental conditions, wholly or partially. They are high system structures made in different ways by covering with light-transmitting material. Greenhouse areas have changed over the years according to their characteristics (Table 2.2). In Turkey, an increase of 121% in glass greenhouses, 248% in plastic greenhouses, 429% in high tunnels, and 13% in low tunnels were observed in terms of area (decare) between 1995 and 2019. With a total increase of 118%, the greenhouse sector has gained an important place in the country's economy. While the change in the total area was 47% between 2002 and 2019, this change was 2% between 2018 and 2019.

31 million tons of vegetables were produced in Turkey in 2019. Of this production, 23.2 million tons were produced in the open and 7.8 million tons were produced in the greenhouse. Total greenhouse assets have reached 790 thousand decares. Turkey is among the first four countries in the world in terms of greenhouse existence, and it is in second place after Spain in Europe (Özkan and Yılmaz 1999).

Table 2.2. Status of Greenhouse Agricultural Lands in Turkey According to Their Characteristics Between 1995-2019 (Source: TUIK 2019)

Years	Total (decare)	Glass greenhouse (decare)	Plastic Greenhouse (decare)	High Tunnel (decare)	Low Tunnel (decare)
1995	363,042	34,420	108,677	21,421	198,524
1996	404,709	66,668	98,067	29,867	210,107
1997	442,907	39,399	108,549	27,155	267,804
1998	425,775	46,825	119,255	41,667	218,028
1999	423,143	52,641	137,298	43,089	190,115
2000	422,130	56,558	148,242	44,885	172,445
2001	431,387	60,151	149,780	50,221	171,235
2002	536,030	64,199	180,385	60,954	230,492
2003	483,244	70,111	166,605	61,088	185,440
2004	477,739	71,695	169,257	66,242	170,545
2005	467,540	65,427	171,043	66,916	164,154
2006	469,081	68,353	182,354	69,834	148,540
2007	494,239	75,793	195,180	65,307	157,959
2008	542,158	82,253	211,680	66,960	181,265
2009	567,180	82,932	220,186	77,046	187,016
2010	563,805	80,772	230,543	81,521	170,969
2011	611,451	78,878	247,962	108,910	175,701
2012	617,760	80,728	278,730	95,095	163,207
2013	615,124	80,739	278,661	97,986	157,737
2014	643,442	80,976	298,651	107,095	156,720
2015	660,265	79,977	306,074	112,674	161,541
2016	691,724	80,137	328,745	112,974	169,867
2017	752,168	85,749	355,121	119,899	191,399
2018	772,091	78,110	368,527	114,232	211,222
2019	789,604	75,495	378,670	111,038	224,400

As in the world, most tomatoes are grown in greenhouses in Turkey. Other products grown together with tomatoes are cucumber, eggplant, pepper, watermelon, melon, green beans, curly lettuce, purslane, parsley, etc. listed as (Table 2.3).

Table 2.3. Products Grown in Greenhouse in 2019  
(Source: TUIK 2019)

#	Products	Production (Ton)	Ratio (%)
1	Tomato	4,083,681	48
2	Cucumber	1,156,997	14
3	Watermelon	877,505	10
4	Pepper	749,769	9
5	Banana	424,837	5
6	Eggplant	323,009	4
7	Zucchini	211,953	3
8	Melon	205,340	2
9	Strawberry	195,206	2
10	Others	200,702	2
	<b>TOTAL</b>	<b>8,436,616</b>	

### 2.3. Renewable Energy in Greenhouses

Greenhouses are facilities where suitable environments are provided for plant cultivation, considering the environmental conditions according to the climate of the place where they are located. It is possible to create suitable conditions by installing systems such as heating, cooling, ventilation, lighting, and humidification in greenhouses. Today, there are automatic and fully controlled greenhouses in countries in the cool climate zone such as England and the Netherlands (Tüzel et al. 2015). In Turkey, on the other hand, in countries with hot climates, greenhouse cultivation has developed depending on ecological conditions. Most of the greenhouses are in the Mediterranean Region. In recent years, greenhouse cultivation has become widespread in all regions of Turkey, especially with the cheap and easy procurement of polyethylene cover materials. It is seen that the greenhouses covered with polyethylene are increasing and becoming more widespread day by day in the Central Anatolia and Eastern Anatolia regions where the continental climate is dominant. However, the share of heating in controlled greenhouses in production costs has increased up to 60% in regions where greenhouses are widespread and have continental climate characteristics.

To reduce high costs, producers leave the greenhouse empty until the first week of March after the last harvest in the last week of November. As a result, production in these regions decreases during the winter months. In Turkey's greenhouses, where energy is quite expensive today, some producers only heat for frost protection. This situation causes the yield and quality of the obtained products to be low. Some enterprises, on the other hand, carry out greenhouse heating with fossil fuels. The harm of fossil energy sources used in greenhouse heating to the environment is CO<sub>2</sub> emissions released into the atmosphere. CO<sub>2</sub> gas increases the greenhouse effect that causes global warming. In order to effectively prevent environmental problems caused by the direct or indirect use of fossil fuels, renewable energy sources should be utilized (Gürbüz 2009). The applicability and application method of renewable energy sources in the agricultural sector vary depending on regional conditions. The main renewable energy sources that can be used in greenhouses are solar energy, wind energy, geothermal energy, and biomass energy. Reducing the cost of heating greenhouses will increase the operating profit in the greenhouse sector, which has an important potential in agriculture, and will make a great contribution to the country's economy (Tüzel et al. 2015). For this reason, importance should be given to the use of renewable energy sources in greenhouses in order to minimize greenhouse heating expenditures and the use of increasingly depleted fossil energy sources. In recent years, new technologies have come to the fore in greenhouses. The purpose of using innovative technologies in greenhouses is to increase the quality-of-life cycle. For this purpose, the analysis of the energy required for the production to be obtained in greenhouse cultivation is of great importance in terms of sustainability. Sustainability in greenhouses can be achieved by increasing energy efficiency. Increasing energy efficiency is possible by using renewable energy sources that do not produce waste instead of fossil energy sources.

## **2.4. Solar Energy in Turkey**

Solar energy is the radiant energy released by the conversion of hydrogen gas into helium in the core of the sun. The intensity of solar energy outside the Earth's atmosphere is approximately 1,370 W/m<sup>2</sup>; but due to the atmosphere layer of the earth, the amount reaching the earth varies between 0-1,100 W/m<sup>2</sup>. A small portion of this energy that comes to the world is more than the current energy consumption of the

world. The total energy that the world receives from the sun is  $1.5 \times 10^{15}$  MW/hour in a year (Manzini et al. 2015). This amount of energy is equivalent to 28,000 times the energy consumed by people in the world in one year. According to the International Energy Agency, the amount of sunlight hitting the earth in 90 minutes is enough to meet the energy need of the whole world for one year. The IEA predicts that a large 11% of global electricity generation will be provided by solar energy in 2050, and it reports that by 2030, renewable energy sources will be the energy sources with the fastest growth rate, with an annual growth of 7.6%.

Efforts to utilize solar energy gained momentum, especially after the 1970s, solar energy systems have advanced technologically and have decreased in terms of costs and have been accepted as an environmentally clean renewable energy source. Especially the fact that it is a clean renewable energy source and that it works at a low cost after installation increases the importance of solar energy. Turkey has a high solar energy potential due to its current geographical location. According to Turkey's Solar Energy Potential Atlas, the average annual sunshine duration in Turkey is 2,741.07 hours/year. The average annual total radiation intensity is  $1,527.46 \text{ kWh/m}^2\text{-year}$  (Table 2.4).

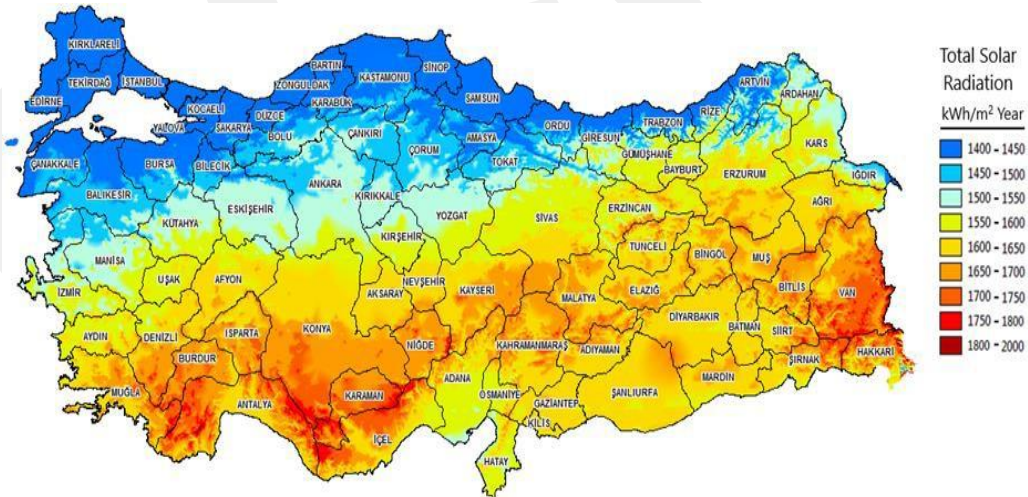

Figure 2.2. Turkey Solar Radiation Map (Source: GEPA)

Table 2.4. Distribution of Turkey's Total Solar Energy Potential by Month  
(Source: GEPA)

Months	Monthly Total Solar Energy (kcal/cm <sup>2</sup> -month) (kWh/m <sup>2</sup> -month)		Sunning Time (hour/month)
January	4.45	51.75	103.0
February	5.44	63.27	115.0
March	8.31	96.65	165.0
April	10.51	122.23	197.0
May	13.23	153.86	273.0
June	14.51	168.75	325.0
July	15.08	175.38	365.0
August	13.62	158.40	343.0
September	10.60	123.28	280.0
October	7.73	89.90	214.0
November	5.23	60.82	157.0
December	4.03	46.87	103.0
<b>Total</b>	112.74	1,311.00	2640
<b>Average</b>	308.0 Cal/cm <sup>2</sup> -day	3.6 kWh/m <sup>2</sup> -day	7.2 hours/day

As can be seen in the Turkish Solar Energy Potential Atlas, insolation potential decreases from south to north (Figure 2.2). The Black Sea Region is the least irradiated region due to its geographical location and the high number of rainy days. Aegean and Marmara Regions receive moderate radiation; Mediterranean, Central Anatolia, Eastern Anatolia, and Southeastern Anatolia Regions are regions that receive high radiation levels. Solar energy investments are more efficient in regions with high levels of radiation, and the return time on investment costs is shorter than in regions with less radiation (Table 2.5).

Table 2.5. Radiation Values and Sunning Times of Regions in Turkey  
(Source: GEPA)

Region	Total Solar Energy (kWh/m <sup>2</sup> -year)	Sunning Time (hour/year)
The Southeastern Anatolia	1,460	2,993
The Mediterranean	1,390	2,956
The Eastern Anatolia	1,365	2,664
The Central Anatolia	1,314	2,628
The Aegean	1,304	2,738
The Marmara	1,168	2,409
The Black Sea	1,120	1,971

While Germany, one of the leading countries in solar energy, has the highest irradiance value of 1,200 kWh/m<sup>2</sup> per year, it is almost the same as the radiation value of the Black Sea Region, which is the least irradiated region of Turkey. From this point of view, the solar energy potential in Turkey cannot be underestimated.

Turkey's total installed power reached 85.2 GW at the end of 2017, 88.5 GW at the end of 2018, and 91.27 GW at the end of September 2019. In recent years, incentives given to power plants that produce electricity from renewable energy sources and domestic sources have had a high impact on this increase. As of September 2019, 49% of Turkey's total installed power consists of renewable energy and 61% of power plants that generate electricity with domestic resources.

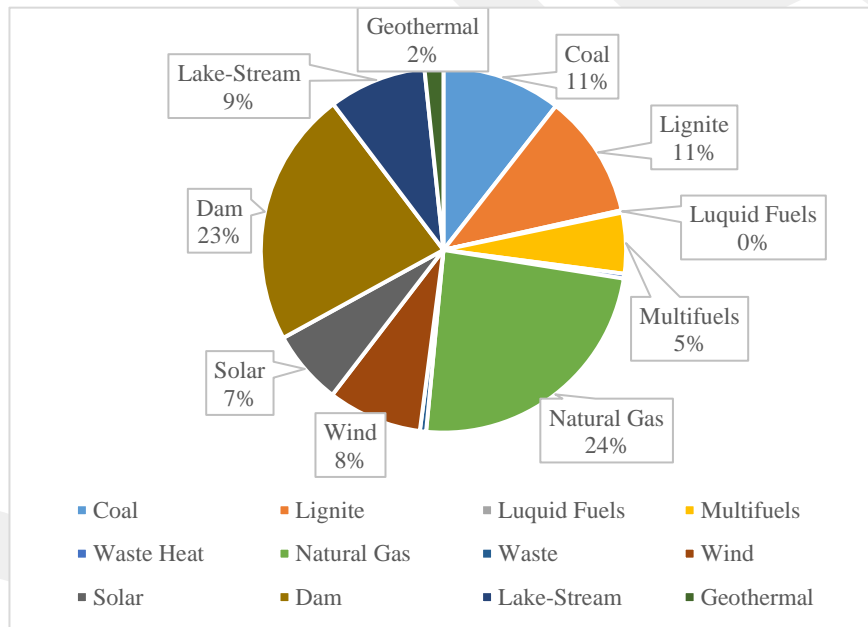

Figure 2.3. Distribution of Turkey's 2019 Installed Power by Resources (Source: TUIK)

Until 2014, solar energy could only be used for producing hot water, drying, etc. in industry and homes. used for transactions. After 2015, solar energy started to be used for electricity generation. Solar energy, whose installed power reached 5,995 MW in 2019, will increase even more in the coming years with new legislation studies on unlicensed roof and facade applications, increases in licensed power plant applications, and Renewable Energy Resource Area applications (Figure 2.4). This increase is expected to be more sharply in the coming years.

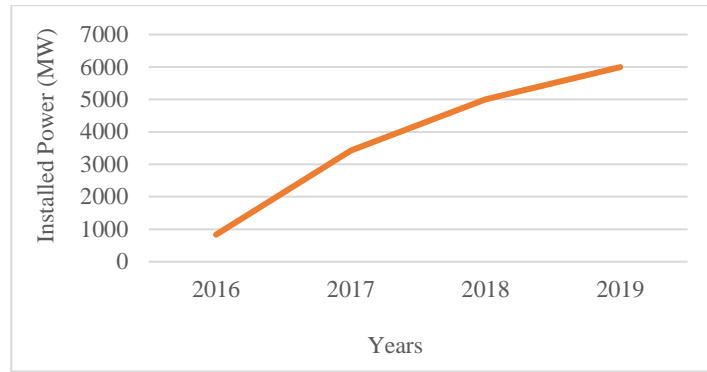

Figure 2.4. Distribution of Turkey's 2019 Installed Power by Solar Energy  
(Source: TUIK)

Two different models are applied in electricity generation from solar energy in Turkey. First, the installed power upper limit of 5 MW or the upper limit of installed power determined by the Council of Ministers Decision by the 14th article of the Law, which is applied to the delivery of the electrical energy produced by the real and legal persons producing electrical energy to the system. Its appearance is the 303 grid-connected unlicensed generation model or isolated generation model without the need for a grid (without establishing a connection to the transmission or distribution system). The other model is the larger-scale licensed production model with grid connection (Pardossi, Tognoni, and Incrocci 2004).

Power plants producing unlicensed electricity in Turkey are designed as small-scale systems that meet the owner's consumption without the need for a grid or are connected to the grid and give their surplus production to the grid. For unlicensed electricity generation, Turkey Electricity Generation Company explains the current transformer capacities. According to the data of March 2019; within the scope of the Regulation on Unlicensed Electricity Production in the Electricity Market, a total of 6,346.21 MW capacity has been allocated to unlicensed electricity generation from solar and wind energy and a call letter with a total capacity of 6,191.92 MW has been given for unlicensed solar power plant installation. While the number of licensed solar power plants was 9 in 2018, it increased to 17 in 2019; The number of unlicensed solar power plants increased from 5,859 to 6,884 in the same years. As in previous years, an increase is observed in unlicensed power plants. As of the end of 2018, the installed power of unlicensed solar power plants constituted 5.6% of Turkey's total installed power with 4,981.2 MW. At the end of 2018, the total installed power of licensed solar

power plants was 81.7 MW, which was 0.1% of Turkey's total installed power, while in 2019 with 169.7 MW, it constituted 0.2% of Turkey's total installed power.

## **2.5. Renewable Energy Regulation**

The 'Regulation for Unlicensed Electricity Production in the Electricity Market', which explains the procedures involving small and medium-sized enterprises of renewable energy producers, was published by the Official Gazette of the Republic of Turkey. The purpose of the Regulation on Unlicensed Electricity Production in the Electricity Market is to meet the electricity needs of consumers in the electricity market from their generation facility closest to the point of consumption, to bring small-scale generation facilities to the country's economy to ensure supply security, and to reduce the number of losses in the electricity grid by ensuring effective use of small-scale generation resources. It is to determine the procedures and principles to be applied to real or legal persons who can produce electrical energy without the obligation to obtain a license and establish a company to establish a company. Within the scope of the regulation, the procedures to be applied when reintroducing unlicensed and surplus electricity into the grid and the rights and obligations of the business owners are explained. In addition, the ways to be followed in the transfer process of production facilities are detailed in the regulation. The renewable Energy Resources Support Mechanism has been established by the government in Turkey. Thus, incentives, standards, and procedures related to renewable energy production facilities are being implemented through this mechanism. The Renewable Energy Resources Support Mechanism aims to increase the use of renewable energy resources in production.

The generation facilities that can be evaluated within the scope of the Renewable Energy Resources Support Mechanism have the guarantee of selling the electricity they have produced for 10 years at a fixed price. Prices are determined by the Renewable Energy Law, excluding network usage fees; 7.3 US cent/kWh for hydroelectric and wind power generation facilities, 10.5 US cent/kWh for geothermal power generation facilities, and 13.3 US cent/kWh for biomass and solar power generation facilities.

Within the scope of The Renewable Energy Resources Support Mechanism, with the regulation of "Supporting Domestic Parts Used in Facilities Producing Electricity from Renewable Energy Sources", additional incentives are also available

provided that the domestic production components used in the production facility are at a certain level. The purpose of this regulation is to increase the demand for the use of domestic production components. The number of incentives for enterprises varies according to the level of domestic equipment used and production capacity.

Article 5 of the Unlicensed Electricity Generation Regulation in the Electricity Market emphasizes that the generation facility and consumption facilities of the persons who will establish the generation facility must be within the same distribution region. The photovoltaic generation facilities to be installed within the scope of the regulation will be in the low voltage class up to 400 kW, and those over 400 kW will be in the medium voltage class and grid connections will be provided. It may establish a generation facility or facilities within the scope of this regulation by combining its consumptions in facilities belonging to one or more real and/or legal persons, which are in the same tariff group and connected to the same connection point, or whose electrical energy consumption can be measured with a single common meter. If the generation facility will transmit at a low voltage level and over the transformer belonging to the network operator, it cannot exceed 50% of the power of this transformer. If the transformer belongs to the applicant, the said capacity will be as much as the maximum transformer power. By the procedures and principles of the institution to be authorized by the Ministry within the scope of Article 11, the application for the facility where production will be made is evaluated.

Facilities that will produce solar energy can only be realized as roof and facade applications. In systems over 50 kW, the installation of Supervisory Control and Data Acquisition automation systems is mandatory. The generation facility cannot be operated at a power greater than the power included in the connection agreement; penal conditions in the Agreement for Connection to the Distribution System for Unlicensed Electricity Producers are applied.

## CHAPTER 3

### GREENHOUSE INSTALLATION

To remove the harmful effects of external factors that may occur in plant cultivation with the greenhouse installation, to create the necessary climatic conditions, to choose suitable material options; it provides an environment for different cultivations such as vegetables, fruits, cut flowers, seeds, and seedlings. In modern greenhouse systems, systems such as irrigation, fertilization, humidification, heating, cooling, and ventilation are systems that are least dependent on the workforce and include the use of technology. Thanks to the greenhouse installation and the use of modern greenhouse systems, the situation of being affected by geographical conditions and climatic conditions can be seriously controlled. Because while greenhouses protect the plant from unfavorable precipitation, temperature values, wind, and other harmful factors, at the same time, they are partially transparent with the light transmittance needed by the plant and can be used in different sizes, different geometric shapes, and different materials according to the current climatic conditions and geographical conditions in the region, the product to be grown and the budget. structures that can be built. In addition, the quality and yield can be increased using modern greenhouse systems such as heating, cooling, irrigation, ventilation, humidification systems, and different growing cultures.

Total vegetable production in greenhouses in Turkey reached 7,535,511, fruit production reached 535,515 tons (“TÜİK” n.d.). Tomato ranks first in vegetable production with a rate of 48%. Table tomato production is carried out in open air and greenhouses in Turkey. The amount of production has been increasing every year for many years. As a matter of fact, the tomato production amount, which was 8.5 million tons in 2001, reached 12.84 million tons in 2019 with an increase of 51%. 8,836.055 tons of this production amount is table tomatoes. Of this, 4,083,681 tons were produced under greenhouses (“TÜİK” n.d.). The widespread use of greenhouse tomato cultivation in recent years has increased its production and efficiency (Gül 2019).

Tomato is a warm and hot climate vegetable; does not like the cold. If the temperature drops to -2 °C during the growing period, the plant will be completely

damaged. When the temperature drops below 14 °C, maturation is delayed and yield decreases. The optimum temperature for plant growth is 14-18 °C at night and 22-26 °C during the day. In general, when the temperature rises above 26 °C, the greenhouses should be ventilated. The humidity rate in the area where tomatoes are grown should be 65-80%. The optimum size of the greenhouses can be considered between 100 – 250,000 m<sup>2</sup> for vegetables in order to optimize the operating and marketing costs (Dannehl et al. 2014).

Light is also important in tomato cultivation. It should be grown in places with at least 6 hours of direct sunlight. Tomatoes, which are exposed to light for a maximum of 14 hours in technological greenhouses, should be left without light for 10 hours and be in a dormant state. Tomatoes are not very picky in terms of soil. It gives the best results in soils rich in nutrients (nitrogen, phosphorus, potassium) and with a pH of 5-7. Generally, there is approximately 91 cm of working space between rows of tomatoes 71-76 cm apart. According to the data of the study area, it is taken as a reference that 2,500 tomato seedlings are grown in 1 decare with optimum yield in tomato cultivation in greenhouses in our country (Abdel-Mawgoud et al. 1996).

In this study, based on tomato cultivation in two different regions, the Mediterranean Region and the Eastern Anatolia Region, the installation of two greenhouses with the same characteristics, the energy calculations required for heating, the heat loss calculations in the greenhouses, the total energy need and the design of the photovoltaic panels corresponding to this need will be examined. An economic analysis of these sample greenhouse designs will be made. The size of the sample greenhouse in this study was designed as 10 decares and other information about the greenhouse is shown in Table 3.1.

Table 3.1. Technical Specifications of The Sample Greenhouse

<b>Crop</b>	Tomatoes
<b>Greenhouse Indoor Area</b>	20,000 m <sup>2</sup>
<b>Annual Full Capacity Production Amount</b>	700 tons
<b>Cover Material Side walls</b>	Polycarbonate, roof cover polyethylene
<b>Peak Height</b>	7.50 m
<b>Height Under Groove</b>	5.00 m
<b>Truss Width</b>	9.60 m
<b>Inner Column Spacing</b>	5.00 m
<b>Side Column Spacing</b>	2.50 m
<b>Clipper Spacing</b>	2.50 m
<b>Snow Load</b>	20 kg/m <sup>2</sup>
<b>Construction Material</b>	Hot-dip galvanized steel

### 3.1. Construction

The height of the greenhouse, the cover material, and the number of partitions in the greenhouses built as blocks affect the greenhouse climate (temperature, humidity, CO<sub>2</sub> and light). In order to provide suitable climatic conditions in the greenhouse, a large buffer zone should be created between the roof area and the plant environment. Thus, the rapid fluctuations that may occur in the greenhouse environment in terms of temperature and humidity will be reduced. The higher the buffer zone between the plant and the roof area in the greenhouse, the easier it will be for the enterprise to control natural production factors such as light, temperature, and humidity.

In this study, walls and roofs will be covered with polycarbonate by using steel construction material. Steel is resistant to corrosion for many years. Polycarbonate sheets maximize the use of natural light energy and help regulate the internal temperature for a more effective heating and cooling system, thanks to their high insulation properties. The reason why polycarbonate materials are preferred in greenhouse construction is their durability in all weather conditions, their ability to absorb the bad effects of sun rays, and their resistance to ultraviolet rays. It also minimizes the risk of dew and frost in the greenhouse in winter; It accelerates plant development by preventing plants from getting stressed. It is resistant to breakage caused by hail and impact. It diffuses the light. Its advantage over plastic is its longevity.

In this study, study will be carried out on a greenhouse of 10,000 square meters. All design principles will be determined on this square meter. Greenhouse systems, consisting of galvanized special-function profiles shaped according to the needs in roll form forming stations at high-quality standards, are completely bolt-joined and modular. The greenhouse system has been built considering the European Standard TS-EN/13031 greenhouse design criteria, which determines the structural designs and construction features of the greenhouses in the project design, as well as being long-lasting against corrosion and rusting. In this context, greenhouse elements are examined separately as foundation, column, truss, rain and roof gutters and fasteners.

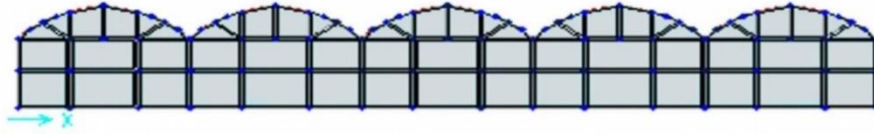

Figure 3.1. Front View of Sample Greenhouse Design  
(Courtesy of Emre İçöz)

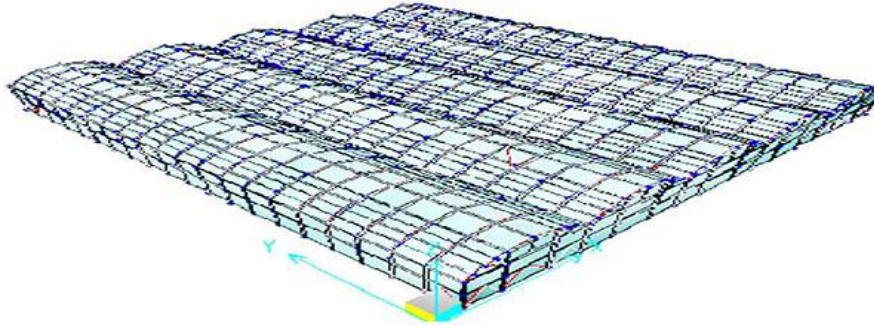

Figure 3.2. Top View of Sample Greenhouse Design  
(Courtesy of Emre İçöz)

### 3.1.1. Base

Depending on the soil structure, foundation pits will be opened at a depth of 80-100 cm. Column stirrups will be 127 x 127 cm in size and 50 cm thick. 63 x 63 cm size 60 cm high concrete will be poured on the foundation pit. The perimeter columns of the greenhouse will be connected all around with 30 cm above-ground bond beam concrete, and the middle column foundations will be strengthened. Anchor profiles to be used are 177.8 x 177.8 in cm size.

### 3.1.2. Columns

Columns in the sample greenhouse will be designed with an engineering approach against buckling, bending and shear forces from plant and wind loads, with 80×80 mm dimensions and 2 mm wall thickness in order to meet the compression and tensile stresses. The regions where the wall thickness per unit area is increased will be placed symmetrically at the midpoints of the lateral surfaces of the profile, continuing along the profile. The profile corners are rounded by giving radiuses. In this way, it is 5 times more resistant to buckling and vertical loads than normal column profiles.



Figure 3.3. Columns of Sample Greenhouse Design  
(Courtesy of Emre İçöz)

### 3.1.3. Clippers

The loads will be distributed equally and evenly to the greenhouse columns by dividing the loads into 5 equal sections at the bottom and top of the column and using 10 mesh materials. It is planned to distribute the loads that may be encountered not only in compression but also in tension, to the column in a balanced manner.



Figure 3.4. Shears of Sample Greenhouse Design  
(Courtesy of Emre İçöz)

### 3.1.4. Rain Gutters

Rain gutters are produced in multi-station roll-form machines in a form that can meet loads of the gothic structure and make rainwater discharge for many years without any problems. It is in the form that transmits the transpiration waters inside the greenhouse to the outside of the greenhouse, providing a protected environment against

diseases for controlled plant production with good humidity control. The opening of the grooves in the sample greenhouse design will be 50 cm. It is planned to provide high water carrying capacity with its deep structure, high static strength and minimum shade ratio with its ribbed structure.



Figure 3.5. Rain Gutters of Sample Greenhouse Design  
(Courtesy of Emre İçöz)

### 3.1.5. Connectors

Clamps connect elements in the greenhouse; It provides weldless and modular assembly by molding in special form and design. The fasteners are multifunctional and perform several functions at the same time, providing practicality and speed of assembly. Bolts and nuts planned to be used in the sample greenhouse design are galvanized and all nuts are used with fiber against loosening in vibrations. The bolt group to be used in the connection is steel. Bolt norms are DIN-931, DIN-933, DIN-985, DIN-125, DIN7504N and DIN-934. All of the clamps to be used are of 2 mm galvanized material, the radius points are in an engineering design that will spread the distribution of loads evenly to the connection area and have passed the static tests successfully.

### 3.2. Air Conditioning

In order to obtain high quality and high efficiency from greenhouses, factors such as temperature, humidity, light, and CO<sub>2</sub> must be at certain compatibility levels. Most of the plant species grown in greenhouses are warm-season plants and the climatic characteristics of these plants are given below.

1. Average 17°C - 27°C is suitable for plants grown in greenhouses. Considering the greenhouse effect resulting from solar radiation, there is no need for heating in greenhouses if the daily average temperature values are between 12°C - 22°C.

2. In case the daily average temperature drops below 12°C, the greenhouses must be heated especially at night.
3. When the daily average temperature rises above 22°C, additional cooling measures should be taken in greenhouses. Otherwise, plant growth in the greenhouse stops. If the daily average temperature is between 12°C - 22°C, natural ventilation is sufficient for air conditioning in greenhouses.
4. For good plant growth, the temperature difference between day and night should be between 5°C - 7°C.
5. In case the outdoor temperature rises above 27°C, cooling systems must be installed in the greenhouses.
6. For plants, the temperature in the greenhouse should not exceed 35°C – 40°C.
7. The total day length value in the three months of the year (November, December, and January) should be between 500 - 550 hours.
8. Soil temperature should be at least 15°C.
9. Air humidity between 70-90% is accepted as a reliable range.

Heating has positive effects on increasing efficiency and quality in the greenhouse, as well as other advantages. One of the problems that arise in unheated greenhouses is high humidity. Chemical pesticides used against diseases caused by high humidity in the greenhouse harm human and environmental health. It is possible to sell the products obtained from the heated greenhouses at higher prices in the domestic and foreign markets (Kacira et al. 2004).

One of the important technical infrastructures that the plants in the greenhouse should have to fulfill the physiological demands of the climate is the heating system. The tomato plant becomes inactive at temperatures below 13 °C, especially in winter, and stops almost all biological reactions. It is necessary to have a good heating system in order to increase the product and quality in unit m<sup>2</sup>. This heating system is the factor that directly affects the fruit formation period, fruit quality, fruit weight/caliber, and plant status.

This study, it is aimed to use a ground source heat pump in the greenhouse design. The fact that the temperature changes of the soil are more stable than the air will provide the appropriate climate for the exemplary greenhouse design to be examined in the Eastern Anatolia and Mediterranean regions. Ground source heat pumps use the ground as a low-temperature energy source. Using the carrier fluid circulated in the heat

exchangers installed in the ground source, the low-temperature thermal energy obtained from the soil is brought to high temperatures by the heat pump system, and the thermal need of the environment to be heated is met. Soil temperature is not significantly affected by seasonal temperature changes and remains relatively constant throughout the year. For this reason, high coefficient of efficiency (COP) values are achieved in heating – cooling applications with ground source heat pumps. Although the initial investment costs of ground source heat pumps are higher than that of air-source heat pumps, they are more advantageous than other systems due to their lower operating costs, low maintenance costs, and long equipment life due to their coefficient of efficiency values and can pay the difference between installation costs in a short time.

### **3.3. Ventilation**

Ventilation regulates temperature, humidity, and CO<sub>2</sub> concentration in greenhouses. Natural ventilation in greenhouses is among the cheapest and most suitable air-conditioning measures. Natural ventilation is provided with the help of ventilation covers located on the greenhouse roof and/or greenhouse sidewalls. Roof ventilation should be done in large-volume modern greenhouses to be established as blocks. In large-volume block greenhouses, it is appropriate to have ventilation openings in the roof area. For good ventilation, it is sufficient that the ratio of ventilation openings in the roof area to the greenhouse floor area is 20-25%.

The ventilation windows in the greenhouse in this study will be designed to be controlled by an automation system and will be positioned at 5 cm in each tunnel. Fly nets will be mounted on the ventilation. The motorized ventilation on the back will cover 40% of the ground surface of the greenhouse on average. The butterfly ventilation will be 2.5 x 2 m in size and the opening distance will be 1.8 m. Ventilation will be guided by 1.88 m long 2.5 mm thick threaded rods and pinions. It will create a current of air that sweeps over the roof, helping the flow inside and out. This sweeping effect allows successful dehumidification. Its high opening allows it to create a better airflow than the available air value. It is planned that it will be possible to keep it open during rain and wind time, thanks to its compound structure.

### 3.4. Automatic Irrigation and Fertilization

They are systems that ensure that the water needs of the plants in the greenhouse are met at the same time and the same rate. In order for plants to grow in the same amount and to produce products of equal quality, the amount of water required by each plant must be the same. Not only the amount of water the plant receives, but also the plant nutrients, EC and pH values in the amount of water must be at the same standards.



Figure 3.6. Irrigation System and Filter Systems for Sample Greenhouse Design  
(Courtesy of Emre İçöz)

Drip irrigation systems are the irrigation systems with the highest efficiency that give the daily water requirement of the plants to the root zone without interruption without creating excessive water demand in the plants. In order to ensure the same wetness everywhere in these system applications, it should be planned to be applied with a low flow rate but for a long time. For this purpose, drippers, which are the last element of the system, are hydraulically laminar or turbulent. Generally used heads are available in types that can operate up to 2, 4, 8 l/h flow and 1 bar pressure. It is planned to increase the yield in the greenhouse by using irrigation water and fertilizer very frequently and locally. With this system, savings are achieved in water, fertilizer, labor, and cultural processes. Automatic irrigation – fertilization systems that can do this task have been developed. With the irrigation program prepared in automatic irrigation systems, irrigation amount, time, irrigation duration and chemical fertilizer amount can be determined. Different programs can be made according to the plant type or water

demand and saved in the computer memory for later use. Thus, the amount of water to be given to the plant can be controlled and economical water use is ensured. These systems ensure that all parameters affecting plant growth (EC, pH, temperature, etc.) are supplied to the plant in sufficient quantities with venturi or injector pumps. With irrigation - fertilization systems, different and independent sections can be created in greenhouses, and they can be irrigated separately or together. In this way, it can be ensured that fertilization is done exactly according to the plant and its growth stage.

### 3.5. Automation Systems

Automation systems used in greenhouses; climate control and irrigation - fertilization automation can be examined in two parts. All these processes are carried out by a computer unit that constitutes the brain of automation and a program installed on it.

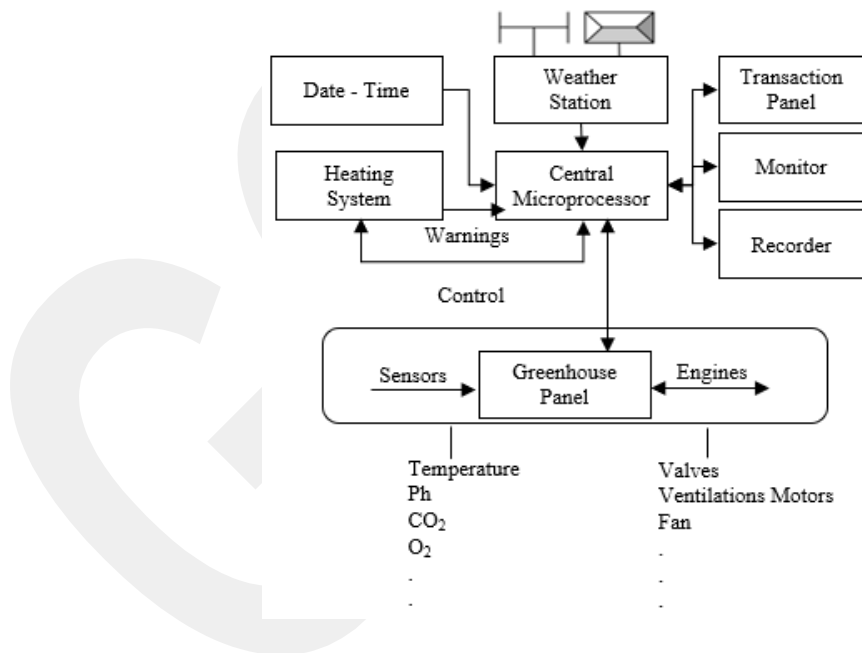

Figure 3.7. Automation Schema for Sample Greenhouse Design

The indoor air temperature, which rises with the effect of the sun in the summer and decreases with the effect of the outside air temperature in the winter, will be kept within the desired limits in different ways with the help of the computer. Natural ventilation with ventilation windows, mechanical ventilation with the help of

ventilators, fogging and cooling with wet pillows (with fan system), while a ground source heat pump is used for heating. Events in the environment have consequences on variables that affect each other. Among these variables, ambient humidity and temperature have a double-sided effect. Because with every increase in temperature with heating, the humidity in the environment decreases proportionally, and every increase in ventilation that encourages a decrease in humidity will also lead to a temperature decrease that will drag the heating-ventilation competition. Fogging will increase the humidity and decrease the temperature. The process responsible for the climate of a greenhouse has a control input signal (such as heat requirement, window opening, CO<sub>2</sub> amount), an atmospheric noise data input signal (such as outside temperature, wind speed, outdoor humidity) and a data output signal (such as humidity generated inside the greenhouse). It is planned to be modeled with processes (such as the amount of CO<sub>2</sub>).

### **3.6. Energy Calculation for Example Greenhouse**

Providing the energy needed in agricultural production from clean and renewable energy sources offers important alternatives for solving economic, social and environmental problems related to energy use. Greenhouse cultivation is a production method that provides the necessary conditions for the production of all kinds of agricultural products with high added value throughout the year, which is more efficient and higher yields than traditional agricultural production methods, which are carried out depending on climatic conditions. However, greenhouse cultivation is more expensive than traditional agricultural production methods in terms of operating and setup costs and requires more technical knowledge and skills. For this reason, it is important to correctly design the designs and operating conditions of greenhouses used in greenhouse cultivation, to obtain the highest level of benefit from these systems (Öztürk 2019).

In this section, the average heat loss of a greenhouse design that will be located in the Mediterranean and Eastern Anatolia regions has been determined and the heating requirement has been analyzed. By introducing the methods and calculations followed in the analysis processes, the values required to determine the thermal properties of the greenhouse are presented. For the sample greenhouse design, heat loss and total thermal

needs during the heating season were calculated as monthly and annual total values. In addition, the operating characteristics of the ground source heat pump system working with electrical energy were determined and the data obtained were presented. The monthly and annual energy needs were calculated by adding the electricity consumption of the greenhouse related to irrigation and automation and the electricity consumption required for heating. Thanks to this study, it was aimed to design the systems used in agricultural production correctly and to provide improvements in production costs with the resulting energy savings. In this study, the thermal properties of the tunnel-type greenhouse with a height of 4+3 m and a total floor area of 10,000 m<sup>2</sup> for both regions were investigated.

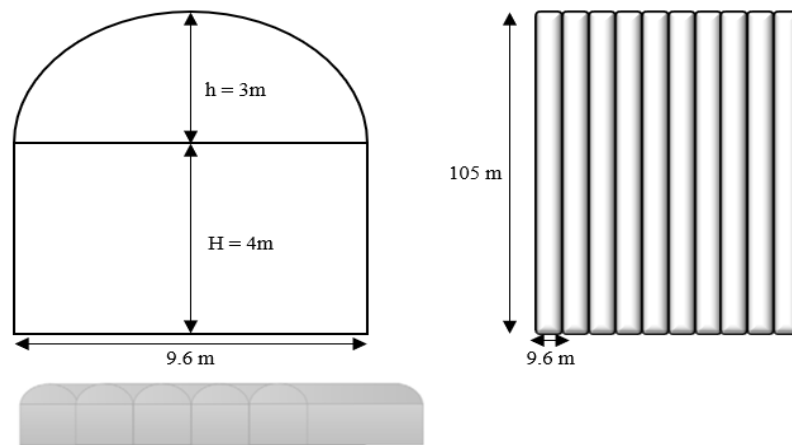

Figure 3.8. Dimensions And Schematic View of The Sample Greenhouse Design

There is no calculation standard for the heat loss calculation of greenhouses in our country. In the literature, there are many different methods for determining the heating needs of greenhouses. However, the values obtained because of the calculations suggested in different methods for the heat loss calculation of a particular greenhouse can vary greatly. Accordingly, when calculating the heat loss value of an existing greenhouse, it is of great importance to determine a calculation method that includes the installation of the greenhouse, the characteristics of the building elements and the operating conditions in detail, in terms of the accuracy of the heat loss calculation. Considering that the heater equipment design to be selected for the greenhouse will be made according to the heat loss calculation, the heat loss calculation has a great role in determining the initial investment and operating costs of the greenhouse and increasing

the benefit to be obtained from the greenhouse. In this chapter, while making the heat loss calculations for the sample greenhouse, the American Society of Agricultural Engineers Standard for Heating, Cooling and Ventilation of Greenhouses ANSI - ASAE EP 406.4 was followed.

According to ANSI - ASAE EP 406.4 standard, the total heat loss value ( $Q_T$ ) in a greenhouse is equal to the sum of the heat transfer value ( $Q_{rc}$ ) from the greenhouse by radiation, convection and conduction and the heat transfer value ( $Q_i$ ) that occurs because of infiltration.

$$Q_T = Q_{rc} + Q_i \quad (1)$$

The heat transfer value  $Q_{rc}$  realized by radiation, convection and conduction are calculated with the help of the following expression.

$$Q_{rc} = U \times A_c \times (t_i - t_o) \quad (2)$$

The parameters that make up the equation are as follows:

$U$  = Total heat transfer coefficient [  $W/m^2\text{°C}$  ]

$A_c$  = Total surface area of greenhouse cover [ $m^2$ ]

$t_i$  = Greenhouse indoor design temperature [ $\text{°C}$ ]

$t_o$  = Outdoor design temperature [ $\text{°C}$ ]

To determine the total heat transfer coefficient ( $U$ ) for the greenhouse, the total heat transfer coefficient chart according to the coating method and material was used. In this study, a single layer of polycarbonate greenhouse cover was used for the sample greenhouse design, and  $U = 6.8 \text{ W/m}^2\text{°C}$ .

$t_i$  [ $\text{°C}$ ] is the greenhouse indoor design temperature and is determined by the thermal requirements of the plant grown in the greenhouse.

The greenhouse interior design temperature values needed for different plants in greenhouse cultivation are available in the literature. In the sample greenhouse to be examined within the scope of this study, tomato cultivation was deemed appropriate, and accordingly, the indoor design temperature for the greenhouse was determined as  $15\text{°C}$  at night,  $24\text{°C}$  during the day, and indoor relative humidity value of 0.7 (Pastakkaya 2014).

$t_o$  [°C] is the outdoor design temperature and can be taken as the average minimum outdoor temperature value of the coldest month for the province where the greenhouse will be established. The coldest month for the Eastern Anatolia region is °C, the average temperature value is -9 °C and the outdoor design temperature value made within the scope of the study was determined as -9 °C. For the Mediterranean region, the coldest month is °C, and the average temperature value is 6 °C, and the outdoor design temperature value made within the scope of the study was determined as 6 °C.  $Q_i$  can be calculated by equation (3) as the heat transfer value that occurs because of infiltration in the greenhouse.

$$Q_i = \rho_i \times N \times V \times [c_{pi} \times (t_i - t_o) + h_{fg} \times (W_i - W_o)] \quad (3)$$

The parameters that make up the equation are as follows;

$\rho_i$  = density of greenhouse air at temperature  $t_i$  [kg/m<sup>3</sup>]

$N$  = Infiltration rate [1/s]

$V$  = Greenhouse volume [m<sup>3</sup>]

$c_{pi}$  = specific heat of indoor air at temperature  $t_i$  [J/kgK ]

$t_i$  = Greenhouse indoor design temperature [°C]

$t_o$  = Outdoor design temperature [°C]

$h_{fg}$  = enthalpy of evaporation of water at temperature  $t_i$  [J/kg]

$W_i$  = Specific humidity of indoor air [kg<sub>water</sub> / kg<sub>air</sub>]

$W_o$  = specific humidity of outdoor air [kg<sub>water</sub> / kg<sub>air</sub>]

The  $N$  parameter in the equation is the infiltration rate, and the infiltration rate for the sample greenhouse in this study was accepted as  $3.1 \times 10^{-4}$  as an average value according to the current working conditions.

$h_{fg}$  is the enthalpy of evaporation of water at  $t_i$  temperature, and it can be obtained from the difference of enthalpy values of water and steam at the same temperature or directly from table values (Cengel and Boles 2019).

$$h_{fg} = h_b - h_s \quad (4)$$

$W_i$  is the specific humidity value of the indoor air; The indoor relative humidity ( $\varphi_i$ ) can be calculated by equation (5), depending on the evaporation pressure of water at  $t_i$  temperature ( $P_{dT_i}$ ) and indoor air pressure ( $P_i$ ).

$$W_i = 0.622 \times (\varphi_i \times P_{dT_i}) / (P_i - \varphi_i \times P_{dT_i}) \quad (5)$$

$W_o$  is the specific humidity value of the outdoor air; outdoor relative humidity ( $\varphi_o$ ) can be calculated by equation (6), depending on the evaporation pressure of water ( $P_{dT_o}$ ) and outdoor air pressure ( $P_o$ ) (open air pressure) at  $t_o$  temperature.

$$W_o = 0.622 \times (\varphi_o \times P_{dT_o}) / (P_o - \varphi_o \times P_{dT_o}) \quad (6)$$

In the study, considering the operating conditions of the greenhouses for both regions, the indoor relative humidity ( $\varphi_i$ ) was 0.7 and the outdoor relative humidity ( $\varphi_o$ ) was 0.8 by taking the average of the outdoor relative humidity measurement values in January in the Eastern Anatolia Region. This value was calculated as 0.6 for the Mediterranean Region. The outdoor air pressure value for the Eastern Anatolia Region was determined as 93.45 kPa and the greenhouse indoor air pressure was taken as equal to this value. For the Mediterranean region, this value is 101.5 kPa.

The heat loss of the sample greenhouse by convection and conduction can be calculated by means of the  $Q_{rc}$  equation (2). The total surface area of the sample greenhouse design is 15,177.6 m<sup>2</sup> and the total volume is 66,499.5 m<sup>3</sup>.

$$Q_{rc} = 6.2 \times 15,177.6 \times (15 - (-9))$$

It is found as  $Q_{rc} = 2,258.43$  kW

$Q_i$  being the heat transfer value that occurs as a result of infiltration in the greenhouse is calculated using equation (3) as follows;

$$Q_i = 1.225 \times 3.1 \times 10^{-4} \times 66499.5 \times [1000.5 \times (15 - (-9)) + 2466110 \times (0.00806 - 0.00153)]$$

$$Q_i = 1,013.1 \text{ kW}$$

Accordingly, the total heat loss value of the greenhouse is found through equation (1).

$$Q_T = Q_{rc} + Q_i = 2,258.4 \text{ kW} + 1013.1 \text{ kW} = 3,272.5 \text{ kW}$$

In order to determine the heating energy, need in greenhouses, and therefore the fuel consumption/energy consumption values in heating and/or cooling applications, it is necessary to determine the months when the greenhouse needs heating and/or cooling. In this section, since the heating of the sample greenhouse is examined, the determination of the monthly and annual total energy needs for heating the greenhouse will be examined. In determining the heating need of the sample greenhouse according to the months, the heating day degrees of the region where the greenhouse is installed, and the monthly average temperature values are taken into account. The  $f_d$  and  $f_n$  coefficients will be used to determine the monthly energy need and fuel consumption values required for heating the greenhouses, and the day length depends on  $d_i$ .

$t_{mmax}$  average maximum outdoor temperature,  $t_{mmin}$  average minimum outdoor temperature,  $t_{mind}$  average minimum daytime temperature. Average daytime hourly temperature value  $t_h$ ;

$$t_h = t_{mind} + f_d \times A \quad (7)$$

Average night temperature value  $t_{mn}$  ;

$$t_{mn} = t_{mind} + A \times (\sum f_n / (24 - d_i)) \quad (8)$$

Average daytime temperature value  $t_{md}$  ;

$$t_{md} = t_{mind} + A \times (\sum f_d / d_i) \quad (9)$$

A represents the difference between the average maximum and minimum daytime temperature.

$$A = t_{maxd} - t_{mind} \quad (10)$$

Meteorological data including  $t_{mmax}$  average maximum outdoor temperature and  $t_{mmin}$  average minimum outdoor temperature values for Eastern Anatolia and Mediterranean regions will be calculated by obtaining through the information provided by the General Directorate of Meteorology. Assuming that the heating application will be carried out in temperate, subtropical, and arid regions and will be applied mostly at night, the monthly total energy amount required for heating can be calculated by equation (11).

$$Q_{(month)} = U \times (A_c / A_g) \times (t_{id} - t_{st} - t_{mn}) \times n_n \times n_d \text{ [Wh/m}^2 \text{ month]} \quad (11)$$

$U$  = Total heat transfer coefficient [W/m<sup>2</sup>K]

$A_c / A_g$  = Greenhouse cover surface area / Greenhouse floor area ratio [-]

$t_{id}$  = Greenhouse indoor design temperature [°C]

$t_{mn}$  = Average night temperature value [°C]

$t_{st}$  = Average value of temperature rise at night due to the heat stored in the soil during the day [°C]

$n_n$  = Number of night hours [-]

$n_d$  = Number of days with heating in the month [-]

The average value of the temperature increases at night due to the heat stored in the soil during the day,  $t_{st}$ , can be taken as 1 – 2 °C (Zabeltitz 2010).

For the sample greenhouse;

$A_c$  = Greenhouse cover surface area

$A_c = 15,177.6 \text{ m}^2$

$A_g$  = Greenhouse floor area

$A_g = 96 \times 105 = 10,080 \text{ m}^2 \approx 10,000 \text{ m}^2$

$A_c / A_g = 7828 / 5000 = 1.52$

$U$  = Total heat transfer coefficient

$U = 6.8 \text{ W/m}^2 \text{ °C}$

$t_{id}$  = Greenhouse indoor design temperature

$t_{id} = 15 \text{ °C}$

As an example, the heating energy requirement in the Eastern Anatolia Region for November only;

$t_{mn}$  = Average night temperature in November [°C]

$$t_{mn} = t_{mind} + A \times (\sum f_n / (24 - d_l))$$

$$t_{maxd} = 15.9 \text{ °C}$$

$$t_{mind} = 3.7 \text{ °C}$$

$$A = t_{maxd} - t_{mind}$$

$$A = 12.2 \text{ °C}$$

$$d_l = 9.9$$

$$\sum f_n / (24 - d_l) = 0.389$$

$$t_{mn} = 3.7 + (12.2 \times 0.389) = 8.45$$

$$t_{st} = 2 \text{ °C}$$

$n_n$  = Number of night hours

$$n_n = 14.1 \text{ hours}$$

$n_d$  = Number of days of heating in the month

$$n_d = 30 \text{ days}$$

November heating energy need  $Q_{(NOVEMBER)}$ ;

$$Q_{(NOVEMBER)} = U \times (A_c / A_g) \times (t_{id} - t_{st} - t_{mn}) \times n_n \times n_d$$

$$Q_{(NOVEMBER)} = 6.8 \times 1.52 \times (15 - 2 - 8.45) \times 14.1 \times 30$$

$$Q_{(NOVEMBER)} = 19,863.87 \text{ Wh/m}^2 \text{ month}$$

For the monthly energy need of the entire greenhouse;

$$19,863.87 \times 10,000 \text{ m}^2 = 198,638.87 \text{ kWh}$$

$$Q_{(NOVEMBER)} = 198,638.87 \text{ kWh}$$

It is envisaged that the sample greenhouse will be heated for 6 months in the Eastern Anatolian Region and 4 months in the Mediterranean Region. In the tables below (Table 3.2, Table 3.3), the energy need for the heating need in both regions in the relevant months is calculated in kWh.

Table 3.2. Monthly Heating Energy Requirement for The Sample Greenhouse Design in The Eastern Anatolia Region

	November	December	January	February	March	April	Total
<b>U</b> (W/m <sup>2</sup> °C)	6.8	6.8	6.8	6.8	6.8	6.8	
<b>A<sub>c</sub></b> (m <sup>2</sup> )	15,177	15,177	15,177	15,177	15,177	15,177	
<b>A<sub>g</sub></b> (m <sup>2</sup> )	10,000	10,000	10,000	10,000	10,000	10,000	
<b>t<sub>id</sub></b> (°C)	15	15	15	15	15	15	
<b>t<sub>st</sub></b> (°C)	2	2	2	2	2	2	
<b>t<sub>mn</sub></b> (°C)	8.45	3.82	0.88	2.89	6.81	11.38	
<b>n<sub>n</sub></b> (hours)	14.1	14.6	14.3	13.4	12.2	11	
<b>n<sub>d</sub></b> (hours)	30	31	31	29	31	30	
<b>Q<sub>month</sub></b> (kWh/m <sup>2</sup> )	19,863	42,881	55,451	40,547	24,161	5,517	
<b>Q<sub>month</sub></b> (kWh)	198,638	428,814	554,513	405,476	241,615	55,174	

Table 3.3. Monthly Heating Energy Requirement for The Sample Greenhouse Design in The Mediterranean Region

	December	January	February	March	Total
<b>U</b> (W/m <sup>2</sup> °C)	6.8	6.8	6.8	6.8	
<b>A<sub>c</sub></b> (m <sup>2</sup> )	15,177.60	15,177.60	15,177.60	15,177.60	
<b>A<sub>g</sub></b> (m <sup>2</sup> )	10,000.00	10,000.00	10,000.00	10,000.00	
<b>t<sub>id</sub></b> (°C)	15	15	15	15	
<b>t<sub>st</sub></b> (°C)	2	2	2	2	
<b>t<sub>mn</sub></b> (°C)	11	9.5	9.7	11.2	
<b>n<sub>n</sub></b> (hours)	14.5	14.3	13.4	12.3	
<b>n<sub>d</sub></b> (hours)	31	31	29	31	
<b>Q<sub>month</sub></b> (kWh/m <sup>2</sup> )	9,278.37	16,013.19	13,235.15	7,083.56	
<b>Q<sub>month</sub></b> (kWh)	92,783.70	160,131.88	132,351.46	70,835.56	

The electrical energy required for irrigation and automation systems to be included in the sample greenhouse design and the electrical energy required for heating were collected and the electrical energy required for both regions was calculated in kWh (Table 3.4, Table 3.5). For the ground source heat pump to be used for air conditioning,

the heat source temperature can be taken as 15 °C on average (Pastakkaya 2005). Therefore, the efficiency coefficient (COP) value of the heat pump to be used for both regions is taken as 6. The heating energy requirement resulting from the above calculations is divided by the efficiency coefficient of the heat pump, and the electricity requirement for heating is found. In the exemplary greenhouse design, while the annual energy need for the Eastern Anatolia Region is 494,088.91 kWh, the annual energy need for the Mediterranean Region is 244,211.17 kWh.

Table 3.4. Monthly Energy Requirement for The Sample Greenhouse Design in The Eastern Anatolia Region

	Heating (kWh)	Watering (kWh)	Automation (kWh)	Total Consumption (kWh)
<b>January</b>	92,418.97	10,000.00	5,000.00	107,418.97
<b>February</b>	67,579.45	10,000.00	5,000.00	82,579.45
<b>March</b>	40,269.19	10,000.00	5,000.00	55,269.19
<b>April</b>	9,195.81	10,000.00	5,000.00	24,195.81
<b>May</b>	-	10,000.00	5,000.00	15,000.00
<b>June</b>	-	10,000.00	5,000.00	15,000.00
<b>July</b>	-	10,000.00	5,000.00	15,000.00
<b>August</b>	-	10,000.00	5,000.00	15,000.00
<b>September</b>	-	10,000.00	5,000.00	15,000.00
<b>October</b>	-	10,000.00	5,000.00	15,000.00
<b>November</b>	33,156.44	10,000.00	5,000.00	48,156.44
<b>December</b>	71,469.05	10,000.00	5,000.00	86,469.05
<b>Total</b>				494,088.91

Table 3.5. Monthly Energy Requirement for The Sample Greenhouse Design in The Mediterranean Region

	Heating (kWh)	Watering (kWh)	Automation (kWh)	Total Consumption (kWh)
<b>January</b>	26,688.65	10,000.00	5,000.00	41,688.65
<b>February</b>	22,058.58	10,000.00	5,000.00	37,058.58
<b>March</b>	0	10,000.00	5,000.00	15,000.00
<b>April</b>	0	10,000.00	5,000.00	15,000.00
<b>May</b>	0	10,000.00	5,000.00	15,000.00
<b>June</b>	0	10,000.00	5,000.00	15,000.00
<b>July</b>	0	10,000.00	5,000.00	15,000.00
<b>August</b>	0	10,000.00	5,000.00	15,000.00
<b>September</b>	0	10,000.00	5,000.00	15,000.00
<b>October</b>	0	10,000.00	5,000.00	15,000.00
<b>November</b>	0	10,000.00	5,000.00	15,000.00
<b>December</b>	15,463.95	10,000.00	5,000.00	30,463.95
<b>Total</b>				244,211.17

## **CHAPTER 4**

# **SOLAR PANEL DESIGN IN PHOTOVOLTAIC GREENHOUSE**

Photovoltaic; literally means electricity production from the photon. This production is carried out with the help of photovoltaic (PV) panels. Photovoltaic systems are widely used in the generation of electricity from the sun. Many components come together to form photovoltaic systems. Photovoltaic systems are not just about solar panels. In addition to the panels, some basic components such as a battery, inverter, and charge controller are also very important for these systems. The most basic parts of photovoltaic systems are the parts where the sun and electricity are produced. Charge controller regulates and keeps the direct current energy coming from the solar panel constant and creates a stable direct current electrical energy for charging the batteries. Inverters are devices that convert direct current electrical energy into alternating current electrical energy. Battery quality is very important for off-grid photovoltaic systems with solar storage (Anto and Jose 2014).

In this study, the on-grid design of solar panels is planned. The reason for this is that if the electricity needed in the winter months when the heating is done in the sample greenhouse design is more than the photovoltaics produced, it can be supplied from the grid to the greenhouse. In the months when heating is not available and electricity self-consumption is low, the excess electrical energy produced by photovoltaics will be returned to the grid. With the electricity distribution company in the region where the sample greenhouse design will take place, it is planned to generate income from the electricity production of the greenhouse, especially in the months when the greenhouse is not heated, with the business model of offsetting according to the status of the electricity produced and consumed on a monthly basis. Model of grid-connected photovoltaic system Figure 4.1 is also shown.

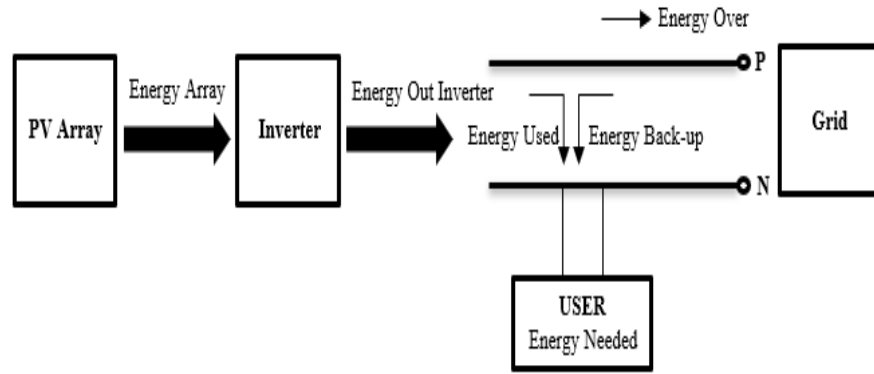

Figure 4.1. Grid Connect Photovoltaic System Diagram

In order to obtain realistic results for the sample greenhouse design made for the Eastern Anatolia Region and the Mediterranean Region, the coordinates of the provinces of Malatya and Antalya were taken as reference. The photovoltaic system was modelled by designing the panel layouts to be on the land where the greenhouses will be located. Meteorological data will be taken from the website of the Turkish Meteorology General Directorate.

#### 4.1. Solar Panel Design for the Eastern Anatolia Region

Malatya province, which is taken as a reference province in the Eastern Anatolia Region, is located at 38.14 °E longitude and 38.32 °N latitude coordinates. The height is 981 meters. Solar panels are designed as fixed and 30° inclination, without shading, and connected to the grid. The nominal installed power is 350 kWp and consists of solar panels with a nominal power of 395 Wp. In the design, there are 12 inverters with a power of 33 kWac

Table 4.1. Photovoltaic Modules in Design

<b>Photovoltaic Module</b>	
Unit Nominal Power	395 Wp
<b>Total PV Power</b>	
Installed Power	350 kWp
Total	885 modules
Module area	1776 m <sup>2</sup>
Cell area	1542 m <sup>2</sup>

Table 4.2. Inverters in the Design

<b>Inverter</b>	
Unit Nominal Power	33 Wp
<b>Total Inverter Power</b>	
Total Power	396 kWac
Number of Inverters	12 units
DC:AC	0.88

As a result of the design, the energy production, energy loss and performance ratio of the system are defined. The amount of radiation falling on the area where the system is installed is 1,870 kWh/m<sup>2</sup> per year. Considering the panel efficiency, temperature and inverter losses, the annual amount of energy that the designed system produces to the grid is 650 MWh. The annual loss diagram is given in Figure 4.2. While the energy suitable for use is more in the summer months, it is less in the winter months due to the decrease in the sunshine hours. Figure 4.3. represents a total energy output of 5.1 kWh/day during the year, photovoltaic arrays losses of 0.75 kWh/day and system or inverter losses of 0.09 kWh /day. Monthly changes in the energy produced on a monthly basis for a year vary depending on the radiation coming to the panel surface, average temperature values, array efficiency, and final efficiency.

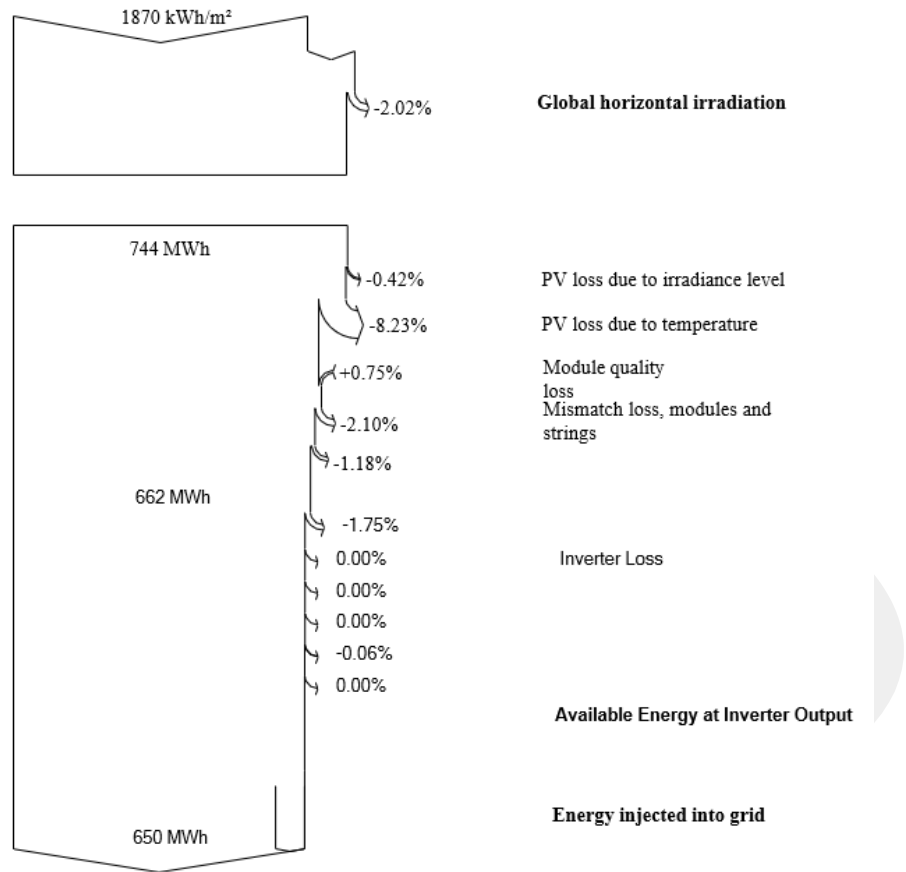

Figure 4.2. Annual Loss Diagram

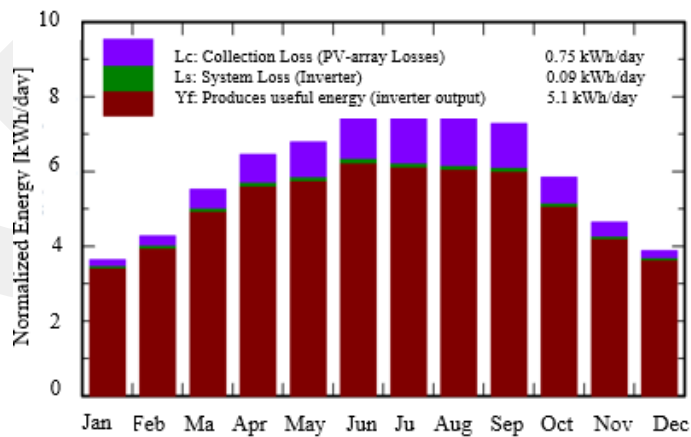

Figure 4.3. Normal Production and Loss Factors

## 4.2. Solar Panel Design for the Mediterranean Region

Antalya province, which is taken as a reference province in the Mediterranean Region, which is the second region where this study is examined, is at 30.79 °E longitude and 37.03 °N latitude coordinates. The height is 116 meters. Solar panels are designed as fixed and 30° inclination, without shading and connected to the grid. The nominal installed power is 175 kWp and consists of solar panels with a nominal power of 395 Wp. In the design, there are 6 inverters with a power of 33 kWac.

Table 4.3. Photovoltaic Modules in Design

Photovoltaic Module	
Unit Nominal Power	395 Wp
<b>Total PV Power</b>	
Installed Power	175 kWp
Total	442 modules
Module area	887 m <sup>2</sup>
Cell area	770 m <sup>2</sup>

Table 4.4. Inverters in the Design

Inverter	
Unit Nominal Power	33 Wp
<b>Total Inverter Power</b>	
Total Power	198 kWac
Number of Inverters	6 units
DC:AC	0.88

As a result of the design, the energy production, energy loss and performance ratio of the system are defined. The amount of radiation falling on the area where the system is installed is 1,638 kWh/m<sup>2</sup> per year. Considering the panel efficiency, temperature and inverter losses, the annual amount of energy that the designed system produces to the grid is 272.3 MWh. The annual loss diagram is given in Figure 4.4. While the energy suitable for use is more in the summer months, it is less in the winter months due to the decrease in the sunshine hours. Figure 4.5 represents a total energy output of 4.27 kWh/day during the year, photovoltaic arrays losses of 0.66 kWh/day and

system or inverter losses of 0.08 kWh /day. Monthly changes in the energy produced on a monthly basis for a year vary depending on the radiation coming to the panel surface, average temperature values, array efficiency, and final efficiency.

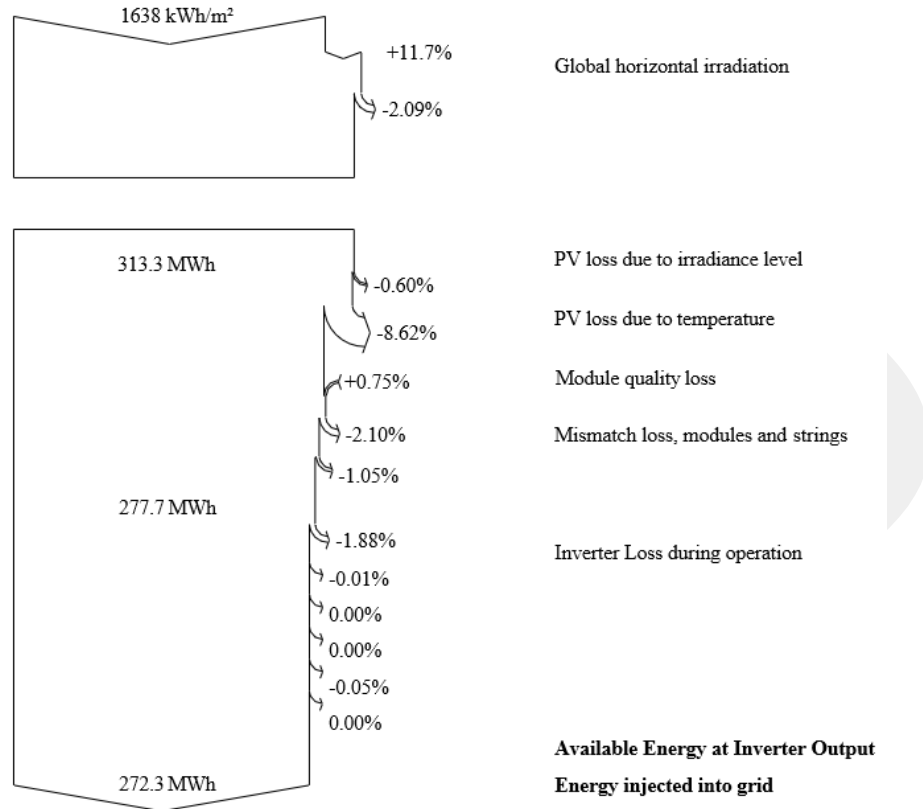

Figure 4.4. Annual Loss Diagram

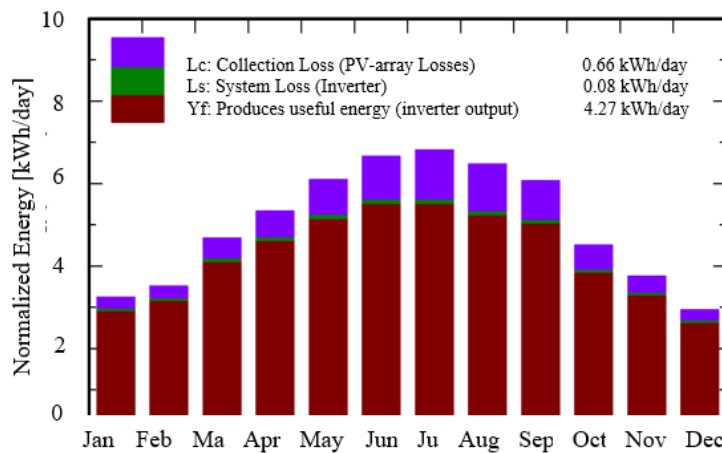

Figure 4.5. Normal Production and Loss Factors

## CHAPTER 5

### TECHNO-ECONOMIC ANALYSIS

Greenhouses are places where agricultural production is fast, efficient, and sustainable regardless of the region when optimum conditions are provided. Energy need for heating is a major cost item in ensuring optimum conditions in greenhouses where production will continue in the winter months, and it sometimes causes the producer to decide not to produce in winter. Considering the high energy costs and the negative effects of non-renewable energy sources on the environment, the integration of renewable energy into sustainable agriculture is inevitable. Despite the high initial investment cost of the energy production system from renewable sources; It is an important investment to eliminate the negativities in product cultivation and make production sustainable with minimum damage to provide an environment for growing every product every month of the year.

This section has been prepared to examine the techno-economic analysis of the use of photovoltaic panels in greenhouse activities. In this analysis, two separate greenhouses, located in the Eastern Anatolia and Mediterranean regions of Turkey, where tomato cultivation will be carried out and which have the same structural characteristics, will be discussed. It has been designed to meet the electricity self-consumption with solar energy, which is renewable energy, and the design of the on-grid photovoltaic system and the investment costs of these greenhouses will be examined. In addition to the need for heating, which is a serious item for electricity consumption in winter, other electricity consumption items are met by photovoltaic panels and from the grid if needed; with the monthly offsetting method of the greenhouse, whose electricity self-consumption decreases in the summer months when there is no heating; it is foreseen that the annual total electricity costs will decrease by supplying the generated electricity to the grid through the bidirectional meter. On the other hand, there is a government-supported 10-year purchase guarantee for the electricity to be produced with photovoltaic panels.

## 5.1. Economic Analysis of Solar Greenhouse

One of the important and decisive analyzes regarding the implementation of photovoltaic investments in greenhouses is the financial analysis of the investment. The financial analysis process aims to present investment requirements and long-term projections. In this section, the basic parameters to be used in the financial analysis process will be defined and the investment of sample greenhouse designs in the Mediterranean and Eastern Anatolia regions will be examined to better understand these parameters.

### 5.1.1. Economic Analysis and Parameters Used

Several parameters are important in interpreting the economic analysis of an investment. In this analysis, a 25-year real study was conducted with 2020 prices.

A 25-year operating life is envisaged for photovoltaic panels. Therefore, the financial analysis of this study will be made over 25 years. Considering the lifetime of photovoltaic panels, their efficiency will be taken as 58% on average. While the installed power of photovoltaic panels for the Mediterranean Region is 175 kW, the installed power for the Eastern Anatolia Region is evaluated as 350 kW. In addition, after the first year of investment for tomato production, it is predicted that the production yield will continue with an increase of 9% for 25 years, as the soil gets used to and optimum conditions are provided. This parameter should also be considered in the calculations.

**MARR (Minimum Attractive Rate of Return):** The minimum rate that an investor expects to earn when investing in a project. In other words, it is the minimum rate of return to cover the costs of an investment. MARR can also be taken as a large ratio to consider the high degree of risk that investments can pose. Therefore, the MARR value will be taken as 5% when making the calculations, since it is aimed to prove that the return of the greenhouse investment and the application of the photovoltaic system integrated into the greenhouse is a high investment. Corporate tax in Turkey is applied gradually over the total annual gross earnings of businesses. For the calculations to be

simple and understandable, an average rate will be taken as the basis of the application (Riggs, Bedworth, and Randhawa 1996).

Table 5.1. MARR & Corporate Income Tax

<b>MARR</b>	5.0%
<b>Corporate Income Tax</b>	25%

According to the Law on the Use of Renewable Energy Resources for Electricity Generation, the unit prices of the Renewable Energy Resources Support Mechanism are determined as 133 dollars/MWh for solar power plants (Riggs, Bedworth, and Randhawa 1996). In the calculations, the electricity unit price will be taken as 0.13 USD/kWh. According to the data from the Ministry of Agriculture and Forestry, the selling price of tomatoes will be 0.70 USD/kg.

Table 5.2. Electricity Price

<b>Electricity price (USD/kWh)</b>	0.13
<b>Tomato Price (USD/kg)</b>	0.70

Two main cost items need to be calculated in the financial analysis for solar greenhouse installation. These are the initial investment cost and annual costs. Initial investment cost; includes the cost of agricultural land, greenhouse installation cost and installation cost of the photovoltaic system. Annual costs include greenhouse operating expenses, greenhouse employee costs and annual maintenance costs of the photovoltaic system. These costs will be taken equally the greenhouses to be examined in both regions.

Table 5.3. Cost Summary for the Mediterranean and Eastern Anatolia Regions

Cost Items	Mediterranean Region	Eastern Anatolia Region
Farmland Cost	\$44,000	\$35,000
Greenhouse Installation Cost	\$509,462	\$509,462
Photovoltaic System Installation Cost	\$168,735	\$244,468.35
Working Capital	\$21,788	\$22,162
<b>Total Initial Investment</b>	<b>\$743,984</b>	<b>\$811,092</b>
Greenhouse Operating Cost	\$45,703	\$45,703
Greenhouse Employee Cost	\$46,980	\$46,980
Annual Maintenance Cost	\$440	\$440
<b>Total Annual Cost</b>	<b>\$93,123</b>	<b>\$93,123</b>

**Working Capital:** Assets such as stocks and trade receivables, which are necessary for an investment to start its daily activities after realizing the investments in fixed assets such as the production facility, are called working capital. Working capital is found by dividing annual expenses by the operating turnover coefficient. If the activity turnover period is accepted as 2 months for greenhouses, the activity turnover coefficient will be taken as 6 in the analysis since it is calculated by dividing the number of months in a year by the activity turnover period. In the financial analysis, the working capital for both regions were calculated by dividing the annual expenditure for that year by 6. In the 25-year financial analysis, the average value of the working capital was taken (Riggs, Bedworth, and Randhawa 1996).

**DC (Depreciation Cost):** Depreciation, that is, depreciation, is the expense share that can be shown in cases such as the wear or obsolescence of the assets purchased for use by the enterprises. The depreciation share of each piece of equipment is different. In the financial analysis in this study, depreciation in five categories will be examined. Three of them are greenhouse-related machinery, construction, and other greenhouse equipment.

The machine amortization period for greenhouses is 10 years, 3 years for construction equipment and 5 years for other equipment. The depreciation period of the agricultural lands where the greenhouses will be located is 25 years and the depreciation period of the photovoltaic system is 10 years (Riggs, Bedworth, and Randhawa 1996).

**SV (Scrap Value):** The amount obtained if machinery and equipment investments are sold due to the end of their economic life after a certain period after this investment is made. In calculations, 1% of the initial material investment will be taken at the end of the period.

**NCF (Net Cash Flow):** It is the net income from operating an investment, after deducting all expenses.

**NPM (Net Profit Margin):** It is the ratio of the net profit of an investment to the revenues. The net profit margin shows how much of each dollar of revenue collected is turned into profit.

**NCP (Net Cash Position):** It represents the amount of cash an investment currently has, and the net cash it has received over some time.

**NPV (Net Present Value):** It is equal to the difference between the present value of an investment's cash inflows and the present value of its cash outflows. It is used in financial analysis to show whether an investment is profitable or not by converting each of the investment's expenses and incomes over time to its present value at an interest rate appropriate to the level of risk.

Revenue and expense analysis for the sample solar greenhouse design in the 25-year analysis was performed in MS Excel for both regions.

Table 5.4. Revenue Summary for the Mediterranean Region

Years	Net Electricity Production (kwh)	Electricity Revenue	Scrap Value	Tomato Efficiency	Tomato Revenue	Total Revenue
0						\$0.00
1	95,375.99	\$12,398.88	\$0.00	100.00%	\$241,920.00	\$254,318.88
2	94,422.23	\$12,274.89	\$0.00	101.50%	\$245,548.80	\$257,823.69
3	93,478.01	\$12,152.14	\$0.00	103.00%	\$249,177.60	\$261,329.74
4	92,543.23	\$12,030.62	\$0.00	104.00%	\$251,596.80	\$263,627.42
5	91,617.80	\$11,910.31	\$0.00	105.00%	\$254,016.00	\$265,926.31
6	90,701.62	\$11,791.21	\$0.00	106.00%	\$256,435.20	\$268,226.41
7	89,794.60	\$11,673.30	\$0.00	106.50%	\$257,644.80	\$269,318.10
8	88,896.66	\$11,556.57	\$0.00	107.00%	\$258,854.40	\$270,410.97
9	88,007.69	\$11,441.00	\$0.00	107.50%	\$260,064.00	\$271,505.00
10	87,127.61	\$11,326.59	\$0.00	108.00%	\$261,273.60	\$272,600.19
11	86,256.34	\$11,213.32	\$0.00	108.50%	\$262,483.20	\$273,696.52
12	85,393.78	\$11,101.19	\$0.00	109.00%	\$263,692.80	\$274,793.99
13	84,539.84	\$10,990.18	\$0.00	109.00%	\$263,692.80	\$274,682.98
14	83,694.44	\$10,880.28	\$0.00	109.00%	\$263,692.80	\$274,573.08
15	82,857.49	\$10,771.47	\$0.00	109.00%	\$263,692.80	\$274,464.27
16	82,028.92	\$10,663.76	\$0.00	109.00%	\$263,692.80	\$274,356.56
17	81,208.63	\$10,557.12	\$0.00	109.00%	\$263,692.80	\$274,249.92
18	80,396.54	\$10,451.55	\$0.00	109.00%	\$263,692.80	\$274,144.35
19	79,592.58	\$10,347.04	\$0.00	109.00%	\$263,692.80	\$274,039.84
20	78,796.65	\$10,243.56	\$0.00	109.00%	\$263,692.80	\$273,936.36
21	78,008.69	\$10,141.13	\$0.00	109.00%	\$263,692.80	\$273,833.93
22	77,228.60	\$10,039.72	\$0.00	109.00%	\$263,692.80	\$273,732.52
23	76,456.31	\$9,939.32	\$0.00	109.00%	\$263,692.80	\$273,632.12
24	75,691.75	\$9,839.93	\$0.00	109.00%	\$263,692.80	\$273,532.73
25	74,934.83	\$9,741.53	\$44,482.32	109.00%	\$263,692.80	\$339,704.85

Table 5.5. Cost Summary for the Mediterranean Region

Years	Total Annual Cost	Depreciation Cost	Taxable Income	Tax Payment	Net Annual Cost
0					\$743,984.38
1	\$93,123.00	\$127,766.50	\$33,429.38	\$8,357.34	\$101,480.34
2	\$93,123.00	\$127,766.50	\$36,934.19	\$9,233.55	\$102,356.55
3	\$93,123.00	\$127,766.50	\$40,440.24	\$10,110.06	\$103,233.06
4	\$93,123.00	\$55,923.42	\$114,581.00	\$28,645.25	\$121,768.25
5	\$93,123.00	\$55,923.42	\$116,879.90	\$29,219.97	\$122,342.97
6	\$93,123.00	\$40,086.82	\$135,016.59	\$33,754.15	\$126,877.15
7	\$93,123.00	\$40,086.82	\$136,108.28	\$34,027.07	\$127,150.07
8	\$93,123.00	\$40,086.82	\$137,201.15	\$34,300.29	\$127,423.29
9	\$93,123.00	\$40,086.82	\$138,295.18	\$34,573.80	\$127,696.80
10	\$93,123.00	\$40,086.82	\$139,390.37	\$34,847.59	\$127,970.59
11	\$93,123.00	\$1,760.00	\$178,813.52	\$44,703.38	\$137,826.38
12	\$93,123.00	\$1,760.00	\$179,910.99	\$44,977.75	\$138,100.75
13	\$93,123.00	\$1,760.00	\$179,799.98	\$44,949.99	\$138,072.99
14	\$93,123.00	\$1,760.00	\$179,690.08	\$44,922.52	\$138,045.52
15	\$93,123.00	\$1,760.00	\$179,581.27	\$44,895.32	\$138,018.32
16	\$93,123.00	\$1,760.00	\$179,473.56	\$44,868.39	\$137,991.39
17	\$93,123.00	\$1,760.00	\$179,366.92	\$44,841.73	\$137,964.73
18	\$93,123.00	\$1,760.00	\$179,261.35	\$44,815.34	\$137,938.34
19	\$93,123.00	\$1,760.00	\$179,156.84	\$44,789.21	\$137,912.21
20	\$93,123.00	\$1,760.00	\$179,053.36	\$44,763.34	\$137,886.34
21	\$93,123.00	\$1,760.00	\$178,950.93	\$44,737.73	\$137,860.73
22	\$93,123.00	\$1,760.00	\$178,849.52	\$44,712.38	\$137,835.38
23	\$93,123.00	\$1,760.00	\$178,749.12	\$44,687.28	\$137,810.28
24	\$93,123.00	\$1,760.00	\$178,649.73	\$44,662.43	\$137,785.43
25	\$93,123.00	\$1,760.00	\$244,821.85	\$61,205.46	\$154,328.46

Table 5.6. Revenue Summary for the Eastern Anatolia Region

Years	Net Electricity Production (kwh)	Electricity Revenue	Scrap Value	Tomato Efficiency	Tomato Revenue	Total Revenue
0						\$0.00
1	193,522.09	\$25,157.87	\$0.00	100.00%	\$241,920.00	\$267,077.87
2	191,586.87	\$24,906.29	\$0.00	101.50%	\$245,548.80	\$270,455.09
3	189,671.00	\$24,657.23	\$0.00	103.00%	\$249,177.60	\$273,834.83
4	187,774.29	\$24,410.66	\$0.00	104.00%	\$251,596.80	\$276,007.46
5	185,896.55	\$24,166.55	\$0.00	105.00%	\$254,016.00	\$278,182.55
6	184,037.58	\$23,924.89	\$0.00	106.00%	\$256,435.20	\$280,360.09
7	182,197.21	\$23,685.64	\$0.00	106.50%	\$257,644.80	\$281,330.44
8	180,375.24	\$23,448.78	\$0.00	107.00%	\$258,854.40	\$282,303.18
9	178,571.48	\$23,214.29	\$0.00	107.50%	\$260,064.00	\$283,278.29
10	176,785.77	\$22,982.15	\$0.00	108.00%	\$261,273.60	\$284,255.75
11	175,017.91	\$22,752.33	\$0.00	108.50%	\$262,483.20	\$285,235.53
12	173,267.73	\$22,524.81	\$0.00	109.00%	\$263,692.80	\$286,217.61
13	171,535.05	\$22,299.56	\$0.00	109.00%	\$263,692.80	\$285,992.36
14	169,819.70	\$22,076.56	\$0.00	109.00%	\$263,692.80	\$285,769.36
15	168,121.51	\$21,855.80	\$0.00	109.00%	\$263,692.80	\$285,548.60
16	166,440.29	\$21,637.24	\$0.00	109.00%	\$263,692.80	\$285,330.04
17	164,775.89	\$21,420.87	\$0.00	109.00%	\$263,692.80	\$285,113.67
18	163,128.13	\$21,206.66	\$0.00	109.00%	\$263,692.80	\$284,899.46
19	161,496.85	\$20,994.59	\$0.00	109.00%	\$263,692.80	\$284,687.39
20	159,881.88	\$20,784.64	\$0.00	109.00%	\$263,692.80	\$284,477.44
21	158,283.06	\$20,576.80	\$0.00	109.00%	\$263,692.80	\$284,269.60
22	156,700.23	\$20,371.03	\$0.00	109.00%	\$263,692.80	\$284,063.83
23	155,133.23	\$20,167.32	\$0.00	109.00%	\$263,692.80	\$283,860.12
24	153,581.90	\$19,965.65	\$0.00	109.00%	\$263,692.80	\$283,658.45
25	152,046.08	\$19,765.99	\$52,055.74	109.00%	\$263,692.80	\$357,676.59

Table 5.7. Cost Summary for the Eastern Anatolia Region

Years	Total Annual Cost	Depreciation Cost	Taxable Income	Tax Payment	Net Annual Cost
0					\$811,092.41
1	\$93,123.00	\$134,979.92	\$38,974.95	\$9,743.74	\$102,866.74
2	\$93,123.00	\$134,979.92	\$42,352.17	\$10,588.04	\$103,711.04
3	\$93,123.00	\$134,979.92	\$45,731.91	\$11,432.98	\$104,555.98
4	\$93,123.00	\$63,136.84	\$119,747.62	\$29,936.91	\$123,059.91
5	\$93,123.00	\$63,136.84	\$121,922.72	\$30,480.68	\$123,603.68
6	\$93,123.00	\$47,300.24	\$139,936.85	\$34,984.21	\$128,107.21
7	\$93,123.00	\$47,300.24	\$140,907.20	\$35,226.80	\$128,349.80
8	\$93,123.00	\$47,300.24	\$141,879.95	\$35,469.99	\$128,592.99
9	\$93,123.00	\$47,300.24	\$142,855.06	\$35,713.76	\$128,836.76
10	\$93,123.00	\$47,300.24	\$143,832.51	\$35,958.13	\$129,081.13
11	\$93,123.00	\$1,400.00	\$190,712.53	\$47,678.13	\$140,801.13
12	\$93,123.00	\$1,400.00	\$191,694.61	\$47,923.65	\$141,046.65
13	\$93,123.00	\$1,400.00	\$191,469.36	\$47,867.34	\$140,990.34
14	\$93,123.00	\$1,400.00	\$191,246.36	\$47,811.59	\$140,934.59
15	\$93,123.00	\$1,400.00	\$191,025.60	\$47,756.40	\$140,879.40
16	\$93,123.00	\$1,400.00	\$190,807.04	\$47,701.76	\$140,824.76
17	\$93,123.00	\$1,400.00	\$190,590.67	\$47,647.67	\$140,770.67
18	\$93,123.00	\$1,400.00	\$190,376.46	\$47,594.11	\$140,717.11
19	\$93,123.00	\$1,400.00	\$190,164.39	\$47,541.10	\$140,664.10
20	\$93,123.00	\$1,400.00	\$189,954.44	\$47,488.61	\$140,611.61
21	\$93,123.00	\$1,400.00	\$189,746.60	\$47,436.65	\$140,559.65
22	\$93,123.00	\$1,400.00	\$189,540.83	\$47,385.21	\$140,508.21
23	\$93,123.00	\$1,400.00	\$189,337.12	\$47,334.28	\$140,457.28
24	\$93,123.00	\$1,400.00	\$189,135.45	\$47,283.86	\$140,406.86
25	\$93,123.00	\$1,400.00	\$263,153.59	\$65,788.40	\$158,911.40

**IRR (The Internal Rate of Return):** The internal rate of return is the rate of return at which the net present value is equal to zero. If the internal rate of return is higher (resp. lower) than the Minimum Attractive Rate of Return, the project will obtain a positive (resp. negative) net present value. By comparing the IRR with the MARR, one can decide whether the investment is viable or not. If the IRR value is greater than the MARR value, the investment is viable, if it is small, the investment is not viable for that period (Riggs, Bedworth, and Randhawa 1996). The IRR values for the Mediterranean

Region and the Eastern Anatolia Region are calculated using the formula on the values of the net cash flows by years in MS Excel in the table below. The feasibility of the investment has been demonstrated by making comparisons with the MARR value taken as 5% for 10, 15 and 25-year periods.

Table 5.8. IRR and MARR Comparison for the Mediterranean Region

<b>Period (years)</b>	<b>IRR</b>	<b>MARR</b>	<b>Investment</b>
<b>10</b>	15.03%	5%	<b>Acceptable</b>
<b>15</b>	18.19%	5%	<b>Acceptable</b>
<b>25</b>	19.53%	5%	<b>Acceptable</b>

Table 5.9. IRR and MARR Comparison for the Eastern Anatolia Region

<b>Period (years)</b>	<b>IRR</b>	<b>MARR</b>	<b>Investment</b>
<b>10</b>	14.64%	5%	<b>Acceptable</b>
<b>15</b>	17.82%	5%	<b>Acceptable</b>
<b>25</b>	19.18%	5%	<b>Acceptable</b>

**ROI (Return on Investment):** ROI shows how much return an investment provides to the investor, i.e., its efficiency, and whether that investment should be sustained. Return on investment is calculated as the ratio of the net present value of all returns to the net present value of all expenditures. ROI is one of the most important data for investment. Undoubtedly, monetary profit/return is provided if the ROI rate of the investment is above 100%.

An ROI of 150% means that for every \$100 invested, \$150 is returned. If this rate is 75% instead of 150%, then it will mean that for the \$100 invested, there is a return of \$75 and a loss of 25%.

Examining the ROI calculations for the photovoltaic greenhouse design investment will provide a better analysis of the project outputs. According to the financial analysis table, the MARR value, and the different ROI values for both regions are shown in Table 5.10.

Table 5.10. Return on Investment for the Mediterranean and Eastern Anatolia Regions

MARR 5%	
ROI (Mediterranean Region)	ROI (Eastern Anatolia Region)
150.33%	151.20%

As a result of the economic analysis made in this study, solar greenhouse investment has a 50.33% profitability rate in the Mediterranean region, while it has a 51.20% profitability rate in the Eastern Anatolia Region.

Also, when NCF (net cash flow) is calculated based on MARR (5%) value for both regions and observed against NCP (net cash position), the investment balance for both regions turns positive after 5 years. This means that the breakeven period for solar greenhouse investment for both regions is 5 years.

Table 5.11. NPV Calculation According to MARR for the Mediterranean Region

Year	NCF (USD)	NCP (MARR) (USD)	Year	NCF (USD)	NCP (MARR) (USD)
0	-743,984.38	-743,984.38	13	136,609.98	1,171,280.31
1	152,838.54	-628,345.06	14	136,527.56	1,366,371.88
2	155,467.14	-504,295.17	15	136,445.96	1,571,136.43
3	158,096.68	-371,413.25	16	136,365.17	1,786,058.42
4	141,859.17	-248,124.74	17	136,285.19	2,011,646.53
5	143,583.34	-116,947.64	18	136,206.01	2,248,434.87
6	141,349.26	18,554.24	19	136,127.63	2,496,984.24
7	142,168.03	161,649.98	20	136,050.02	2,757,883.48
8	142,987.68	312,720.16	21	135,973.20	3,031,750.85
9	143,808.20	472,164.37	22	135,897.14	3,319,235.53
10	144,629.60	640,402.19	23	135,821.84	3,621,019.15
11	135,870.14	808,292.44	24	135,747.30	3,937,817.40
12	136,693.24	985,400.31	25	185,376.38	4,320,084.66
<b>NPV (USD)</b>				<b>1,275,732.97</b>	

Table 5.12. NPV Calculation According to MARR for the Eastern Anatolia Region

Year	NCF (USD)	NCP (MARR) (USD)	Year	NCF (USD)	NCP (MARR) (USD)
0	-811,092.41	-811,092.41	13	145,002.02	1,231,495.82
1	164,211.13	-687,435.90	14	144,834.77	1,437,905.38
2	166,744.05	-555,063.65	15	144,669.20	1,654,469.85
3	169,278.85	-413,537.98	16	144,505.28	1,881,698.62
4	152,947.55	-281,267.32	17	144,343.00	2,120,126.55
5	154,578.87	-140,751.82	18	144,182.34	2,370,315.22
6	152,252.87	4,463.47	19	144,023.29	2,632,854.28
7	152,980.64	157,667.28	20	143,865.83	2,908,362.82
8	153,710.19	319,260.83	21	143,709.95	3,197,490.91
9	154,441.53	489,665.41	22	143,555.62	3,500,921.08
10	155,174.62	669,323.30	23	143,402.84	3,819,369.97
11	144,434.40	847,223.86	24	143,251.58	4,153,590.06
12	145,170.95	1,034,756.00	25	198,765.19	4,560,034.75
<b>NPV (USD)</b>				<b>1,346,590.90</b>	

### 5.1.2. Sensitivity Analysis

Sensitivity analysis is a method used to determine the impact of potential variation in key project variables related to an investment. Sensitivity analysis can be considered as a risk analysis technique to measure the extent to which NPV changes depending on the change in the basic variables that make up the net present value (NPV) of the project. (Uçkun 2001). In this context, sensitivity analysis is a technique

used to identify and estimate potential risk in project efficiency. It is used to estimate the effects of variables on NPV rather than finding the risk value. The effect of changes on the investment according to different assumptions around the most probable value of a fundamental variable, which is considered by keeping other variables constant, is examined. Then the same process is repeated for other variables. When each variable is changed below and above the basic variable at certain rates, new NPVs are calculated provided those other variables remain constant. Project profitability is more sensitive to that variable, whether the change in NPV is greater or when the NPV curve is steeper when graphed. Therefore, the variable in question is the critical variable. A small change or estimation error in the critical variable will lead to large changes in the profitability of the project.

The two main items of the income model in solar greenhouse investment are electricity sales and tomato sales. Changes in electricity and tomato unit prices are the parameters that will affect NPV. Electricity unit prices are subject to annual change against the Turkish Lira due to inflation. At the same time, there has been a change in US Dollar terms over the years. Tomato unit price, which is agricultural production, is also a parameter open to change. Fresh fruits and vegetables, which are agricultural products, are generally products with limited storage possibilities, high input costs and labor needs. Therefore, attention should be paid to the time factor in the marketing of products. The marketing of fresh fruit and vegetable products in Turkey is carried out by the private sector. Brokers, traders and retailers are usually involved in the marketing channel from the producer to the consumer (Özalp and Ören 2016). A producer is defined as a person who grows fresh fruits and vegetables in the greenhouse or the open air. These people transfer all sales rights to the broker in return for a certain commission or market their products to the final sales points through merchants. Due to the difference in the sales channel, tomato unit sales price is an important variable in greenhouse investment.

Table 5.13. Sensitivity of Net Present Value to Electricity Price for the Mediterranean Region

Electricity Price (kWh/USD)	NPV (MARR)(USD)	Electricity Price (kWh/USD)	NPV (MARR)(USD)
	1,275,732.97	0.1495	1,293,641.00
0.2600	1,395,119.80	0.1430	1,287,671.65
0.2535	1,389,150.45	0.1365	1,281,702.31
0.2470	1,383,181.11	0.1300	1,275,732.97
0.2405	1,377,211.77	0.1235	1,269,763.63
0.2340	1,371,242.43	0.1170	1,263,794.29
0.2275	1,365,273.09	0.1105	1,257,824.95
0.2210	1,359,303.75	0.1040	1,251,855.61
0.2145	1,353,334.41	0.0975	1,245,886.27
0.2080	1,347,365.07	0.0910	1,239,916.93
0.2015	1,341,395.73	0.0845	1,233,947.58
0.1950	1,335,426.38	0.0780	1,227,978.24
0.1885	1,329,457.04	0.0715	1,222,008.90
0.1820	1,323,487.70	0.0650	1,216,039.56
0.1755	1,317,518.36	0.0585	1,210,070.22

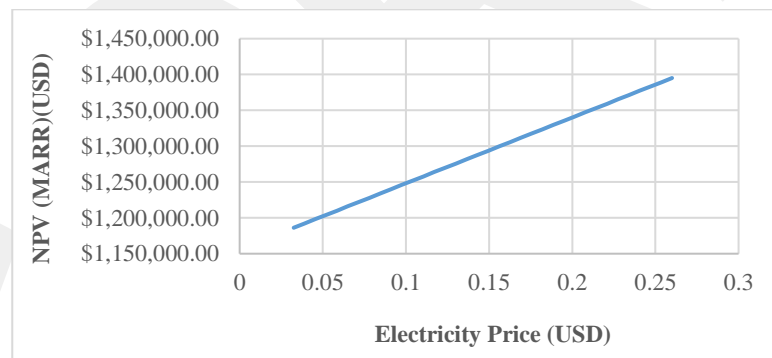

Figure 5.1. Sensitivity Analysis: Net Present Value & Electricity Price for the Mediterranean Region

The solar greenhouse design investment in the Mediterranean Region is based on the NPV value calculated over a 25-year period and the determined MARR value; even if the electricity price drops from 0.13 USD to 0.039 USD per kWh, no risk is foreseen for the investment. The slope of the graph above (Figure 5.1) shows that an increase of 1 USD in the electricity price (USD/kWh) will increase the project value by 918,360.18 USD compared to the net present value. Since the electricity parameter is an income item for this investment, the NPV value will increase as the electricity unit price increases.

Table 5.14. Sensitivity of Net Present Value to Tomato Price for the Mediterranean Region

Tomato Price (kg/USD)	NPV (MARR)(USD)	Tomato Price (kg/USD)	NPV (MARR)(USD)
	1,275,732.97	0.805	1,684,297.65
1.400	3,999,497.50	0.770	1,548,109.43
1.365	3,863,309.27	0.735	1,411,921.20
1.330	3,727,121.05	0.700	1,275,732.97
1.295	3,590,932.82	0.665	1,139,544.75
1.260	3,454,744.59	0.630	1,003,356.52
1.225	3,318,556.37	0.595	867,168.29
1.190	3,182,368.14	0.560	730,980.07
1.155	3,046,179.91	0.525	594,791.84
1.120	2,909,991.69	0.490	458,603.61
1.085	2,773,803.46	0.455	322,415.39
1.050	2,637,615.24	0.420	186,227.16
1.015	2,501,427.01	0.385	50,038.94
0.980	2,365,238.78	0.350	-86,149.29
0.945	2,229,050.56	0.315	-222,337.52
0.910	2,092,862.33	0.280	-358,525.74
0.875	1,956,674.10	0.245	-494,713.97
0.840	1,820,485.88	0.210	-630,902.20

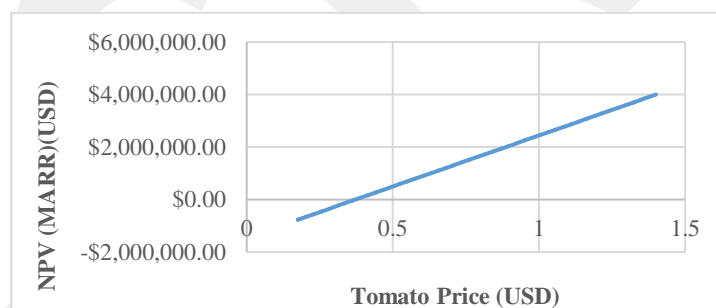

Figure 5.2. Sensitivity Analysis: Net Present Value & Tomato Price for the Mediterranean Region

The solar greenhouse design investment in the Mediterranean Region is based on the NPV value calculated over a 25-year period and the determined MARR value; when the kg/USD price of tomatoes drops from 0.70 USD to 0.35 USD; investment will begin to lose its economic appeal. The slope of the graph above (Figure 5.2.) shows that an increase of 1 USD in the unit price of tomatoes (USD/kg) will increase the project value by 3,891,092.18 USD compared to the net present value. Since the tomato parameter is an income item for this investment, the NPV value will increase as the tomato unit price increases.

Table 5.15. Sensitivity of Net Present Value to Electricity Price for the Eastern Anatolia Region

Electricity Price (kWh/USD)	NPV (MARR) (USD)	Electricity Price (kWh/USD)	NPV (MARR) (USD)
	1,346,590.90	0.1495	1,382,927.07
0.2600	1,588,832.02	0.1430	1,370,815.01
0.2535	1,576,719.97	0.1365	1,358,702.96
0.2470	1,564,607.91	0.1300	1,346,590.90
0.2405	1,552,495.85	0.1235	1,334,478.84
0.2340	1,540,383.80	0.1170	1,322,366.79
0.2275	1,528,271.74	0.1105	1,310,254.73
0.2210	1,516,159.69	0.1040	1,298,142.68
0.2145	1,504,047.63	0.0975	1,286,030.62
0.2080	1,491,935.57	0.0910	1,273,918.56
0.2015	1,479,823.52	0.0845	1,261,806.51
0.1950	1,467,711.46	0.0780	1,249,694.45
0.1885	1,455,599.41	0.0715	1,237,582.40
0.1820	1,443,487.35	0.0650	1,225,470.34
0.1755	1,431,375.29	0.0585	1,213,358.28
0.1690	1,419,263.24	0.0520	1,201,246.23
0.1625	1,407,151.18	0.0455	1,189,134.17
0.1560	1,395,039.13	0.0390	1,177,022.12

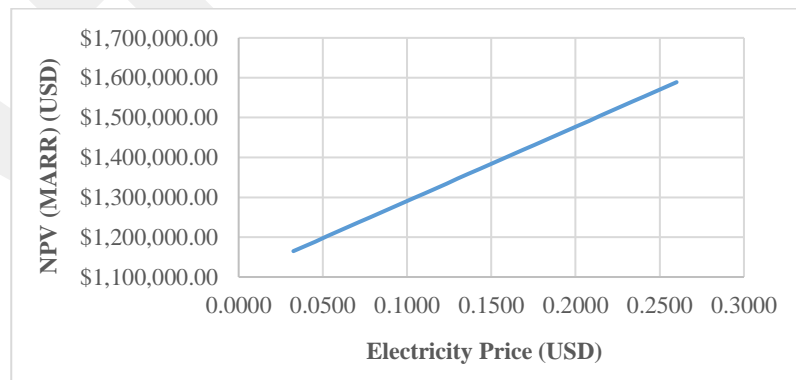

Figure 5.3. Sensitivity Analysis: Net Present Value & Electricity Price for the Eastern Anatolia Region

According to the NPV value calculated according to the 25-year period and the determined MARR value, the solar greenhouse design investment in the Eastern Anatolia Region; even if the electricity price drops from 0.13 USD to 0.039 USD per kWh, no risk is foreseen for the investment. The slope of the graph above (Figure 5.3) shows that an increase of 1 USD in the electricity price (USD/kWh) will increase the project value by 1,863,393 USD compared to the net present value. Since the electricity parameter is an income item for this investment, the NPV value will increase as the electricity unit price increases.

Table 5.16. Sensitivity of Net Present Value to Tomato Price for the Eastern Anatolia Region

Tomato Price (kg/USD)	NPV (MARR)(USD)	Tomato Price (kg/USD)	NPV (MARR)(USD)
	1,346,590.90	0.805	1,755,155.58
1.400	4,070,355.43	0.770	1,618,967.35
1.365	3,934,167.20	0.735	1,482,779.13
1.330	3,797,978.97	0.700	1,346,590.90
1.295	3,661,790.75	0.665	1,210,402.67
1.260	3,525,602.52	0.630	1,074,214.45
1.225	3,389,414.30	0.595	938,026.22
1.190	3,253,226.07	0.560	801,838.00
1.155	3,117,037.84	0.525	665,649.77
1.120	2,980,849.62	0.490	529,461.54
1.085	2,844,661.39	0.455	393,273.32
1.050	2,708,473.16	0.420	257,085.09
1.015	2,572,284.94	0.385	120,896.86
0.980	2,436,096.71	0.350	-15,291.36
0.945	2,299,908.49	0.315	-151,479.59
0.910	2,163,720.26	0.280	-287,667.81
0.875	2,027,532.03	0.245	-423,856.04

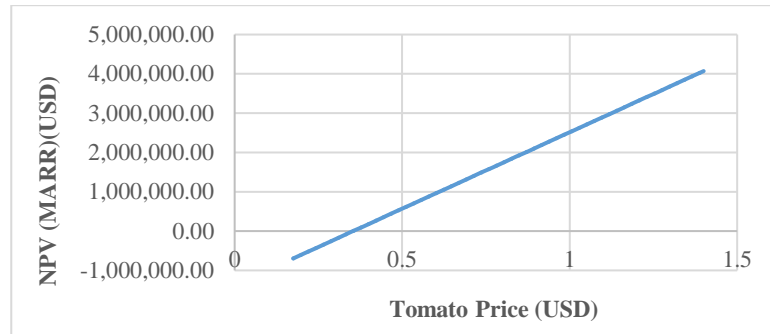

Figure 5.4. Sensitivity Analysis: Net Present Value & Tomato Price for the Eastern Anatolia Region

According to the NPV value calculated according to the 25-year period and the determined MARR value, the solar greenhouse design investment in the Eastern Anatolia Region; when the kg/USD price of tomatoes drops from 0.70 USD to 0.35 USD; investment will begin to lose its economic appeal. The slope of the graph above (Figure 5.4.) shows that an increase of 1 USD in the unit price of tomatoes (USD/kg) will increase the project value by 3,891,092.18 USD compared to the net present value. Since the tomato parameter is an income item for this investment, the NPV value will increase as the tomato unit price increases.

### 5.1.3. Electricity Generation Uncertainty

In the sample greenhouse design, the electricity generation uncertainty of the photovoltaic system designed for the Mediterranean and Eastern Anatolia Regions is important for economic analysis. Because the possibilities of the amount of energy that this system will produce according to the location give information about whether the investment is feasible or not. In the calculation of uncertainty, solar radiation variability and system losses are considered for both regions. Models are made using available data and methods to assess the photovoltaic energy efficiency potential of a PV investment.

The uncertainty distribution in solar energy does not exactly follow the normal distribution. However, the Gaussian uncertainty distribution concept is used, as simplified calculations and statistically representative data are not always available. Weather changes from year to year, in longer-term cycles, and is also stochastic. Therefore, each year solar radiation, air temperature, and PV and inverter energy efficiency may deviate to some extent from the long-term average, called inter-year variability.

The standard deviation of the series of annual values can be converted to the total uncertainty with the following formula (1).

$$U = (U_1^2 + U_2^2 + \dots + U_n^2)^{1/2} \quad (1)$$

The P90 energy calculation typically assumes the variability that can be expected in any given year. The P90 value represents the electricity generation that will occur with a probability of 90%. In addition, the P90 value is also calculated with the following formula (2). In the table below, the accepted uncertainty percentages in calculating the P90 value for the Mediterranean Region are given (Table 5.17). The percentage of total uncertainty for the Mediterranean Region was calculated using the above formula (1). In addition, the NPV and IRR ratios in the economic analyzes made as a result of the P90 value and the electricity production at the P90 value are shown in the table below (Table 5.17).

$$P90 = \text{MEAN} \times (1 - 1.282 \times \text{STDEV}) \quad (2)$$

Table 5.17. Electricity Generation Uncertainty for the Mediterranean Region

<b>The Mediterranean Region</b>	
<b>Year-to-year variability of meteo data</b>	4.6 %
<b>Global variability (meteo + system)</b>	4.9 %
<b>PV Module</b>	1.0 %
<b>Inverter Efficiency Uncertainty</b>	0.5%
<b>Soiling and Mismatch Uncertainty</b>	1.0 %
<b>Degradation Uncertainty</b>	1.0 %
<b>Overall level of uncertainty</b>	7%
<b>P90 (kWh)</b>	255,000.00
<b>NPV (\$)</b>	1,155,073.11
<b>IRR</b>	18.24%

As a result of the uncertainty parameters in the Mediterranean Region, the overall uncertainty rate was 7%. This gives the P90 value, the 7% deviation of the electrical energy expected to be produced by the PV design. This value indicates that the design will produce 255 MWh with a 90% probability. When the economic analysis is done again with a production value of 255 MWh, since the expected electrical energy

production value has a standard deviation of 7%, NPV and IRR value have decreased slightly.

In order to make the same calculations for the Eastern Anatolia Region, the accepted uncertainty percentages, total uncertainty percentage, P90 value, and additionally NPV and IRR values are shown in the table below (Table 5.18).

Table 5.18. Electricity Generation Uncertainty for the Eastern Anatolia Region

<b>The Eastern Anatolia Region</b>	
<b>Year-to-year variability of meteo data</b>	4.3 %
<b>Global variability (meteo + system)</b>	4.6 %
<b>PV Module</b>	1.0 %
<b>Inverter Efficiency Uncertainty</b>	0.5%
<b>Soiling and Mismatch Uncertainty</b>	1.0 %
<b>Degradation Uncertainty</b>	1.0 %
<b>Overall level of uncertainty</b>	6.5%
<b>P90 (kWh)</b>	611,700.00
<b>NPV (\$)</b>	1,251,631.96
<b>IRR</b>	18.25%

As a result of the uncertainty parameters in the Eastern Anatolia Region, the overall uncertainty rate was 6.5%. This gives the P90 value, the 6.5% deviation of the electrical energy expected to be produced by the PV design. This value indicates that the design will produce 611.7 MWh with a 90% probability. When the economic analysis is done again with a production value of 611.7 MWh, since the expected electrical energy production value has a standard deviation of 6.5%, NPV and IRR value have decreased dramatically.

## **5.2. Economic Analysis of Greenhouse Investment Without Photovoltaics**

The most important cost item of greenhouse investments is heating cost. The required electrical energy due to the need for heating greenhouses in winter is a high value. In this case, the annual cost of the greenhouse increases. The economic analysis

of the case where there is no electricity production from any renewable source in the sample greenhouse design in this study is made in this section.

Two basic cost items must be calculated in the financial analysis for a greenhouse installation. These are the initial investment cost and annual costs. The initial investment cost; covers the cost of agricultural land and greenhouse installation cost. Annual costs include greenhouse operating expenses, greenhouse employee costs and electrical energy costs. These costs will be taken equally for the greenhouses to be examined in both regions, and since the heating needs of different regions will be different, only the cost of electrical energy will be different.

Table 5.19. Cost Summary for the Mediterranean and Eastern Anatolia Regions

Cost Items	Mediterranean Region	Eastern Anatolia Region
Farmland Cost	\$44,000	\$35,000
Greenhouse Installation Cost	\$509,462	\$509,462
Working Capital	\$25,693	\$29,576
<b>Total Initial Investment</b>	<b>\$579,155</b>	<b>\$574,038</b>
Greenhouse Operating Cost	\$45,703	\$45,703
Greenhouse Employee Cost	\$46,980	\$46,980
Annual Electricity Cost	\$33,282.21	\$64,225.06
<b>Total Annual Cost</b>	<b>\$125,965.21</b>	<b>\$156,908.06</b>

Examining the ROI calculations for the greenhouse design investment will provide a better analysis of the project outputs. According to the financial analysis table, the MARR value, and the different ROI values for both regions are shown in Table 5.18.

Table 5.20. Return on Investment for the Mediterranean and Eastern Anatolia Regions

MARR 5%	
ROI (Mediterranean Region)	ROI (Eastern Anatolia Region)
134.67%	120.13%

As can be seen in Table 5.17, while the initial investment cost of the greenhouse design investment decreases; due to the annual electricity cost, annual expenditures have increased significantly. As can be seen in Table 5.18, the profitability rate of the

investment has decreased compared to the solar greenhouse investment. Also, when NCF (net cash flow) is recalculated according to MARR (5%) value for both regions and observed according to NCP (net cash position), the investment balance for Mediterranean Region turns positive again after the 6th year; the investment balance in the Eastern Anatolian Region turns positive after the 8th year. This situation can be explained by the fact that the heating need in the Eastern Anatolia Region is higher than in the Mediterranean Region, and in parallel, the cost of electrical energy will be higher.

Table 5.21. NPV Calculation According to MARR for the Mediterranean Region

Year	NCF (USD)	NCP (MARR) (USD)	Year	NCF (USD)	NCP (MARR) (USD)
0	-579,154.95	-579,154.95	13	103,735.69	828,123.63
1	114,689.36	-493,423.33	14	103,735.69	973,265.50
2	117,410.96	-400,683.54	15	103,735.69	1,125,664.47
3	120,132.56	-300,585.15	16	103,735.69	1,285,683.38
4	103,986.19	-211,628.22	17	103,735.69	1,453,703.24
5	105,800.59	-116,409.04	18	103,735.69	1,630,124.09
6	103,655.84	-18,573.65	19	103,735.69	1,815,365.99
7	104,563.04	85,060.71	20	103,735.69	2,009,869.98
8	105,470.24	194,783.99	21	103,735.69	2,214,099.17
9	106,377.44	310,900.63	22	103,735.69	2,428,539.82
10	107,284.64	433,730.31	23	103,735.69	2,653,702.51
11	102,828.49	558,245.31	24	103,735.69	2,890,123.32
12	103,735.69	689,893.27	25	146,187.08	3,180,816.57
<b>NPV (USD)</b>				<b>939,303.95</b>	

Table 5.22. NPV Calculation According to MARR for the Eastern Anatolia Region

Year	NCF (USD)	NCP (MARR) (USD)	Year	NCF (USD)	NCP (MARR) (USD)
0	-574,037.80	-574,037.80	13	80,438.56	425,111.01
1	91,392.23	-511,347.46	14	80,438.56	526,805.12
2	94,113.83	-442,801.01	15	80,438.56	633,583.93
3	96,835.43	-368,105.63	16	80,438.56	745,701.69
4	80,689.06	-305,821.86	17	80,438.56	863,425.33
5	82,503.46	-238,609.49	18	80,438.56	987,035.15
6	80,358.71	-170,181.26	19	80,438.56	1,116,825.47
7	81,265.91	-97,424.42	20	80,438.56	1,253,105.30
8	82,173.11	-20,122.53	21	80,438.56	1,396,199.12
9	83,080.31	61,951.65	22	80,438.56	1,546,447.63
10	83,987.51	149,036.74	23	80,438.56	1,704,208.57
11	79,531.36	236,019.93	24	80,438.56	1,869,857.55
12	80,438.56	328,259.48	25	125,802.08	2,089,152.51
<b>NPV (USD)</b>				<b>616,932.53</b>	

### 5.2.1. Sensitivity Analysis of Greenhouse Investment Without Photovoltaics

Table 5.23. Sensitivity of Net Present Value to Electricity Price for the Mediterranean Region

Electricity Price (kWh/USD)	NPV (MARR)(USD)	Electricity Price (kWh/USD)	NPV (MARR)(USD)
	939,303.95	0.1495	886,532.72
0.2600	587,495.72	0.1430	904,123.13
0.2535	605,086.13	0.1365	921,713.54
0.2470	622,676.55	0.1300	939,303.95
0.2405	640,266.96	0.1235	956,894.36
0.2340	657,857.37	0.1170	974,484.77
0.2275	675,447.78	0.1105	992,075.18
0.2210	693,038.19	0.1040	1,009,665.59
0.2145	710,628.60	0.0975	1,027,256.01
0.2080	728,219.01	0.0910	1,044,846.42
0.2015	745,809.43	0.0845	1,062,436.83
0.1950	763,399.84	0.0780	1,080,027.24
0.1885	780,990.25	0.0715	1,097,617.65
0.1820	798,580.66	0.0650	1,115,208.06
0.1755	816,171.07	0.0585	1,132,798.47

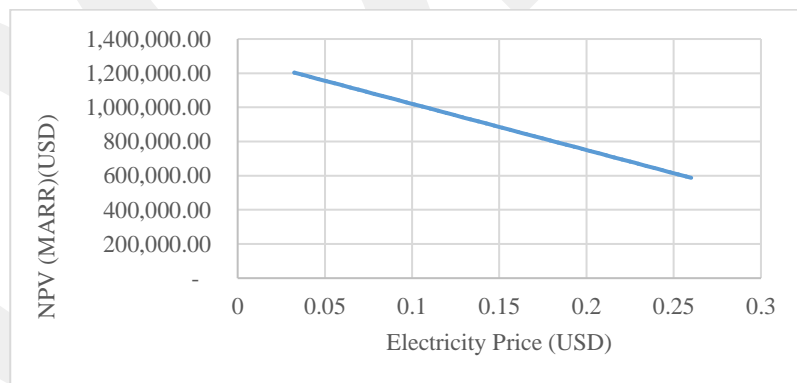

Figure 5.5. Sensitivity Analysis: Net Present Value & Electricity Price for the Mediterranean Region

According to the NPV value calculated according to the 25-year period and the determined MARR value of the greenhouse design investment without photovoltaic in the Mediterranean Region; NPV increases if the electricity price drops from 0.13 USD

per kWh to 0.039 USD. If the unit price of electricity rises, the NPV falls, because electricity parameter is an expense item in greenhouse investment without photovoltaics. The slope of the graph above (Figure 5.5) shows that an increase of 1 USD in the electricity price (USD/kWh) will decrease the project value by 2,706,217.12 USD compared to the net present value.

Table 5.24. Sensitivity of Net Present Value to Tomato Price for the Mediterranean Region

Tomato Price (kg/USD)	NPV (MARR)(USD)	Tomato Price (kg/USD)	NPV (MARR)(USD)
	939,303.95	0.805	1,347,868.63
1.400	3,663,068.48	0.770	1,211,680.40
1.365	3,526,880.25	0.735	1,075,492.18
1.330	3,390,692.02	0.700	939,303.95
1.295	3,254,503.80	0.665	803,115.72
1.260	3,118,315.57	0.630	666,927.50
1.225	2,982,127.34	0.595	530,739.27
1.190	2,845,939.12	0.560	394,551.04
1.155	2,709,750.89	0.525	258,362.82
1.120	2,573,562.67	0.490	122,174.59
1.085	2,437,374.44	0.455	-14,013.63
1.050	2,301,186.21	0.420	-150,201.86
1.015	2,164,997.99	0.385	-286,390.09
0.980	2,028,809.76	0.350	-422,578.31
0.945	1,892,621.53	0.315	-558,766.54
0.910	1,756,433.31	0.280	-694,954.77
0.875	1,620,245.08	0.245	-831,142.99
0.840	1,484,056.85	0.210	-967,331.22

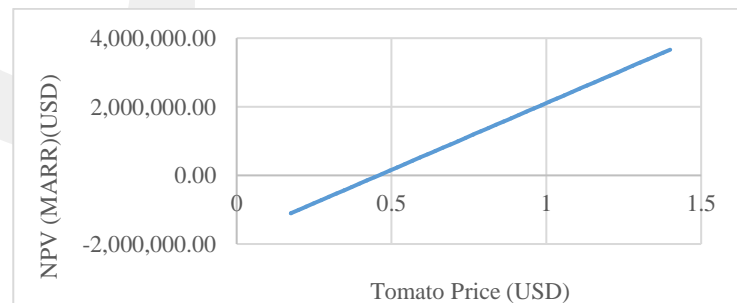

Figure 5.6. Sensitivity Analysis: Net Present Value & Tomato Price for the Mediterranean Region

The sample greenhouse design investment in the Mediterranean Region is based on the NPV value calculated over a 25-year period and the determined MARR value; when the kg/USD price of tomatoes drops from 0.70 USD to 0.46 USD; investment will begin to lose its economic appeal. The slope of the graph above (Figure 5.6) shows that an increase of 1 USD in the unit price of tomatoes (USD/kg) will increase the project value by 3,891,092.18 USD compared to the net present value.

Table 5.25. Sensitivity of Net Present Value to Electricity Price for the Eastern Anatolia Region

Electricity Price (kWh/USD)	NPV (MARR) (USD)	Electricity Price (kWh/USD)	NPV (MARR) (USD)
	616,932.53	0.1495	515,099.28
0.2600	- 61,955.78	0.1430	549,043.70
0.2535	- 28,011.36	0.1365	582,988.11
0.2470	5,933.05	0.1300	616,932.53
0.2405	39,877.47	0.1235	650,876.94
0.2340	73,821.88	0.1170	684,821.36
0.2275	107,766.30	0.1105	718,765.77
0.2210	141,710.71	0.1040	752,710.19
0.2145	175,655.13	0.0975	786,654.60
0.2080	209,599.54	0.0910	820,599.02
0.2015	243,543.96	0.0845	854,543.43
0.1950	277,488.37	0.0780	888,487.85
0.1885	311,432.79	0.0715	922,432.26
0.1820	345,377.20	0.0650	956,376.68
0.1755	379,321.62	0.0585	990,321.10
0.1690	413,266.03	0.0520	1,024,265.51
0.1625	447,210.45	0.0455	1,058,209.93
0.1560	481,154.87	0.0390	1,092,154.34

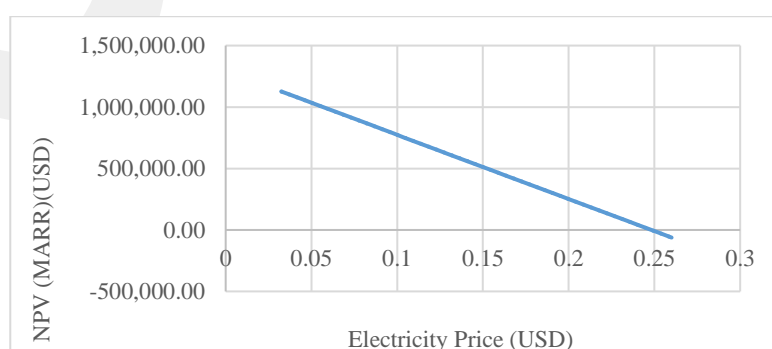

Figure 5.7. Sensitivity Analysis: Net Present Value & Electricity Price for the Eastern Anatolia Region

According to the NPV value calculated relative to the 25-year period and the MARR direction of the greenhouse design without photovoltaic in the Eastern Anatolia Region; NPV increases if the electricity price decreases from 0.13 USD per kWh to 0.039 USD. If the electricity unit price rises to 0.25 USD, the investment will begin to lose its economic appeal. Since the electricity parameter is an expense item in the greenhouse investment without photovoltaic. The slope of the graph above (Figure 5.7) shows that an increase of 1 USD in the electricity price will decrease the project value by 5,222,217.74 compared to the net present value.

Table 5.26. Sensitivity of Net Present Value to Tomato Price for the Eastern Anatolia Region

Tomato Price (kg/USD)	NPV (MARR)(USD)	Tomato Price (kg/USD)	NPV (MARR)(USD)
	616,932.53	0.805	1,025,497.21
1.400	3,340,697.05	0.770	889,308.98
1.365	3,204,508.83	0.735	753,120.75
1.330	3,068,320.60	0.700	616,932.53
1.295	2,932,132.37	0.665	480,744.30
1.260	2,795,944.15	0.630	344,556.07
1.225	2,659,755.92	0.595	208,367.85
1.190	2,523,567.70	0.560	72,179.62
1.155	2,387,379.47	0.525	-64,008.60
1.120	2,251,191.24	0.490	-200,196.83
1.085	2,115,003.02	0.455	-336,385.06
1.050	1,978,814.79	0.420	-472,573.28
1.015	1,842,626.56	0.385	-608,761.51
0.980	1,706,438.34	0.350	-744,949.74
0.945	1,570,250.11	0.315	-881,137.96
0.910	1,434,061.88	0.280	-1,017,326.19
0.875	1,297,873.66	0.245	-1,153,514.42

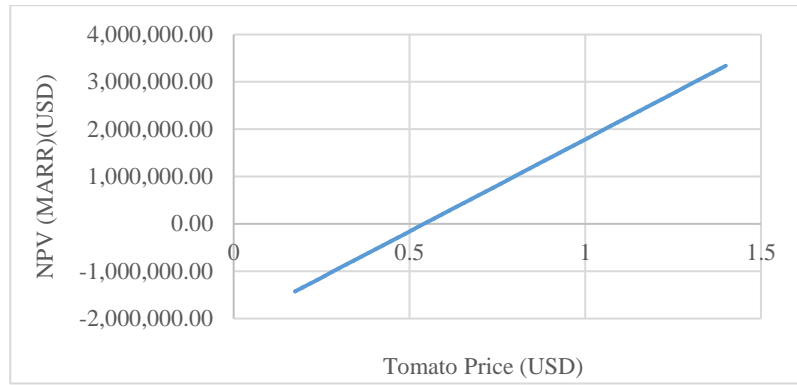

Figure 5.8. Sensitivity Analysis: Net Present Value & Tomato Price for the Mediterranean Region

According to the NPV value calculated according to the 25-year period and the determined MARR value, the exemplary greenhouse design investment in the Eastern Anatolia Region; when the kg/USD price of tomatoes drops from 0.70 USD to 0.53 USD; investment will begin to lose its economic appeal. The slope of the graph above (Figure 5.8) shows that an increase of 1 USD in the unit price of tomatoes (USD/kg) will increase the project value by 3,891,092.18 USD compared to the net present value.

## CHAPTER 6

### CONCLUSION

Considering the energy needs in Turkey and the world, the interest and need for the use of renewable energy sources are increasing day by day. It is obvious that countries direct their energy policies towards renewable energy sources due to the depletion of fossil fuels and the damage they cause to the environment. Solar energy is one of the systems in which renewable energy sources are used. Generating electricity with solar energy; since it is provided both economically and without harming the environment, its use is becoming more and more widespread. They are clean and efficient systems, especially for residences located in rural areas where there is no electricity grid. However, the biggest known disadvantage of solar energy systems is the high initial installation costs. Grid-connected (on-grid) solar energy systems are more efficient and economical than off-grid solar energy systems. Because the system without a grid connection needs to store energy, the battery and battery charge controller will be included as a storage unit in the system to be installed. The materials included will increase the initial setup cost and increase the recycling time. In addition, it is quite risky compared to the grid-connected system, as energy production will stop completely in case of any failure.

The most important cost item of greenhouse investments is heating cost. The required electrical energy is high due to the need for heating greenhouses in winter. In this case, the annual cost of greenhouses increases. Although the investment cost of greenhouses, whose electrical energy needs are met by renewable energy sources, will increase compared to traditional greenhouses, both annual energy costs will decrease and contribute to global warming. In addition to the income of the greenhouse, some of the electricity produced in the summer months when there is no need for heating, as well as the income from food production, will be given to the grid and a profit will be gained from electricity production.

In this thesis, a sample greenhouse design with a size of 10 decares was examined. Optimum conditions for tomato, which is widely grown in greenhouses, which are evaluated separately in the Mediterranean Region and Eastern Anatolia

Regions, which have sunshine hours above the average of Turkey, have been examined. All structural parameters were kept constant for both regions. The most important and variable parameter for regions with different climatic characteristics is temperature. For this reason, heating needs were calculated together with the heat losses according to the structural characteristics of the greenhouses. As a result of the calculations, the electrical energy required for the heating system of a greenhouse with a size of 10 decares in the Mediterranean Region, which is thought to provide optimum conditions for tomatoes, to be met by a ground source heat pump with the efficiency coefficient (COP) of 6, is 76 MWh annually. In the Eastern Anatolia Region, the same value was calculated as an average of 314 MWh annually. While the total electricity need in the Mediterranean Region is 256 MWh, with the consumption of the greenhouse such as automation and irrigation system, it is 494 MWh in Eastern Anatolia.

Considering the electrical energy required for the greenhouse, in particular, a photovoltaic system design with an installed power of 175 kW for the Mediterranean Region and 350 kW for the Eastern Anatolia Region is envisaged. The solar system, which will be connected to the grid (on-grid) in both regions, will meet the majority of self-consumption in winter, while it will press the electricity produced more than needed in the summer to the grid. In order to compare the monthly electricity production of solar panels with consumption, reference provinces were selected from both regions. While Antalya was the reference province for the Mediterranean Region, Malatya was the reference province for the Eastern Anatolia Region. Information such as monthly and daily average sunshine hours required for the production and consumption needs of the designed solar panels have been calculated over these two reference provinces. The solar system designed for both regions can give an average of 27% of annual electricity production to the grid.

The economic analyzes of the solar greenhouse for both regions supported that although the investment cost of photovoltaic systems was high, it paid off in a short time. As a result of economic analysis, solar greenhouse investment turns into profit after the 5th year in both regions. ROI values, on the other hand, are around 150% on average for both regions over a 25-year period according to the 5% MARR value. This value shows that every \$100 invested in solar greenhouse investment returns to the investor as \$150.

The economic analysis of the greenhouse investment without photovoltaics, which has the same characteristics, and is assumed to be produced throughout the year, has also been made. As a result of the economic analysis, the greenhouse investment in the Mediterranean Region turns into profit after the 6th year, while the greenhouse in the Eastern Anatolian Region turns into profit after the 8th year. This result shows how heating energy cost is important and a big part of the greenhouse investment, especially for the Eastern Anatolia Region.

The energy saved in the agricultural sector, which is important for the continuation of humanity, is higher than the energy consumed, and the energy savings will provide significant gains to both the producer and the country's economy. In addition, greenhouse gas emissions are reduced by using the environmentally friendly solar system in greenhouse investment. While the electricity produced in solar greenhouse investment in the Mediterranean Region corresponds to 163 CO<sub>2e</sub> tons, it corresponds to 229 CO<sub>2e</sub> tons in the Eastern Anatolia Region. Energy will be produced with a unique design in the greenhouses and an added value will be provided for the country's economy and the environment.

The reason for all wars today is the desire of countries to have energy resources. Therefore, it should encourage and support the use of not only solar energy but also other renewable energy sources in every sense.

## REFERENCES

- Abdel-Mawgoud, A. M. R., S. O. El-Add, S. M. Singer, A. F. Abou-Hadid, and T. C. Hsiao. 1996. "Effect of Shade on the Growth and Yield of Tomato Plants." *Acta Horti* 434: 313–20.
- Anto, Robins, and Josna Jose. 2014. "Performance Analysis of a 100kw Solar Photovoltaic Power Plant." In 2014 Annual International Conference on Emerging Research Areas: Magnetics, Machines and Drives (AICERA/ICMMD). IEEE.
- Avcıoğlu, A. O., M. A. Dayıoğlu, and U. Türker. 2019. "Assessment of the Energy Potential of Agricultural Biomass Residues in Turkey." *Renewable Energy* 138: 610–19.
- Çengel, Yunus A., and Michael A. Boles. 2019. *Thermodynamics: An Engineering Approach*. 9th ed. Columbus, OH: McGraw-Hill Education.
- Dannehl, D., M. Josuttis, C. Ulrichs, and U. Schmidt. 2014. "The Potential of a Confined Closed Greenhouse in Terms of Sustainable Production, Crop Growth, Yield and Valuable Plant Compounds of Tomatoes." *J. Appl. Bot. Food Qual* 219: 210–19.
- Eltez, Z. R., and G. B. Öztekin. 2011. *Vegetable Cultivation in the Greenhouse*. Vol. Pages. Eskişehir.
- "GEPA." n.d. Gov.Tr. Accessed August 9, 2022. <https://gepa.enerji.gov.tr/MyCalculator>.
- Gül, A. 2019. *Soilless Agriculture* (3. Edition). Vol. 146. İzmir.
- Gürbüz, A. 2009. "The Place and Importance of Renewable (Clean) Energy Resources in the Energy Market." In *International Advanced Technologies Symposium (IATS'09)*. Karabük.
- Kacira, Murat, Sadanori Sase, Ozlem Kacira, Limi Okushima, Masahisa Ishii, Hisashi Kowata, and Hideki Moriyama. 2004. "Status of Greenhouse Production in Turkey: Focusing on Vegetable and Floriculture Production." *Journal of Agricultural Meteorology* 60 (2): 115–22.

- Kadowaki, Masayuki, Akira Yano, Fumito Ishizu, Toshihiko Tanaka, and Shuji Noda. 2012. "Effects of Greenhouse Photovoltaic Array Shading on Welsh Onion Growth." *Biosystems Engineering* 111 (3): 290–97.
- Kothari, A., and N. L. Panwar. 2007. "Steady-State Thermal Model for Predicting Micro-Climate inside the Greenhouse." *J. Agric. Eng. Res* 88: 52–55.
- Manzini, Giovanni, Pasqualino Gramazio, Salvatore Guastella, Claudio Liciotti, and Gian Luigi Baffoni. 2015. "The Fire Risk in Photovoltaic Installations – Checking the PV Modules Safety in Case of Fire." *Energy Procedia* 81: 665–72.
- MGM. n.d. "Meteoroloji Genel Müdürlüğü." Gov.Tr. Accessed August 9, 2022. <https://www.mgm.gov.tr/>.
- "Örtü Altı Yetiştiricilik." n.d. Gov.tr. Accessed August 9, 2022. <https://www.tarimorman.gov.tr/Konular/Bitkisel-Uretim/Tarla-Ve-Bahce-Bitkileri/Ortu-Alti-Yetistiricilik>.
- Özalp, B., and M. N. Ören. 2016. Value Chain Analysis in Agriculture. Paper Presented at the 12th National Agricultural Economics Congress. Isparta.
- Özkan, B. and S. Yılmaz 1999. "Fresh Fruit and Vegetable Marketing in Turkey: Problems and Solution Proposals." *Journal of Akdeniz University Faculty of Agriculture* 12: 157–68.
- Öztürk, G., and S. Engindeniz. 2019. "A Study on the Economic Analysis of Greenhouse Tomato Production in Muğla Province." *Journal of Ege University Faculty of Agriculture* 56 (3): 345–58.
- Pastakkaya, B. 2005. Analysis of Ground Source Heat Pump with Horizontal Type Heat Exchanger. Bursa.
- Pastakkaya, B. 2014. "Thermal System Analysis of Greenhouses in Diyarbakır Province." *International Agricultural Research and Training Center Research Report*.
- Riggs, James L., David Bedworth, and Sabah Randhawa. 1996. *Engineering Economics*. 4th ed. New York, NY: McGraw-Hill.

- Sevgican, A., Y. Tüzel, A. Gül, and R. Z. Eltez. 2000. "Greenhouse Cultivation in Turkey." Turkish Agricultural Engineering V. Technical Congress, Ankara 2: 679–707.
- Sun, J. 2011. "An Optimum Layout Scheme for Photovoltaic Cell Arrays Using PVSYST." In Proceedings 2011 International Conference on Mechatronic Science, 243–45.
- "TÜİK – Data Portal." n.d. Gov.Tr. Accessed August 10, 2022. <https://data.tuik.gov.tr/>.
- Tüzel, Y., and A. Gül. 2008. Good Agricultural Practices in Greenhouses. Vol. 172. İzmir: Tibyan Publishing.
- Tüzel, Y., A. Gül, G. B. Öztekin, Y. Daşgan, S. Engindeniz, and H. F. Boyacı. 2015. "Changes and New Searches in Greenhouse Cultivation." TMMOB Chamber of Agricultural Engineering Turkey Agricultural Engineering VIII. Technical Congress Proceedings 1: 685–709.
- Vermeulen, S., E. Grainger-Jones, and X. Yao. 2014. "Climate Change, Food Security and Small-Scale Producers." In CCAFS Info Brief, CGAIR Research Program on Climate Change, Agriculture and Food Security (CCAFS). Copenhagen.
- Yadav, P. 2015. "Simulation and Performance Analysis of a L0 KW Photovoltaic System Using PVsyst," 358–63.
- Zabeltitz, C. 2010. Integrated Green Houses for Mild Climate. Germany: Springer.